

# ARTICOLI VARI IN PLASTICA

VARIOUS PLASTIC ITEMS  
ARTICLES DIVERS EN PLASTIQUE



**REGGIPIANI E  
BLOCCARIPIANI**  
SHELF  
SUPPORTS DE PLAN ET  
TAQUETS POUR ÉTAGÈRE

**REGGIPIANI E BLOCCARIPIANI**

SHELF

SUPPORTS DE PLAN ET TAQUETS POUR ÉTAGÈRE

**235/A**

Reggipiano in nylon o policarbonato per piani 18 mm.

Nylon or polycarbonate shelf support, for 18 mm shelves.

Support de plan en nylon ou polycarbonate pour plans 18 mm.

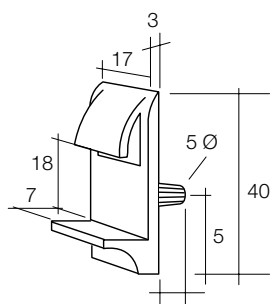

Code	min. order (nr)	qty/box (nr)
235/A/05	8000	8000

**242/L**

Reggipiano ad innesto Ø 14 mm con finestra di bloccaggio, completo di perno Ø 5 mm in metallo art. 245/M.

Slot-in shelf support Ø 14 mm with locking window, complete with Ø5mm metal pin art. 245 / M.

Support de plan à emboîtement Ø 14 mm avec fenêtre de blocage, complété par un goujon Ø 5 mm en métal art. 245/M.

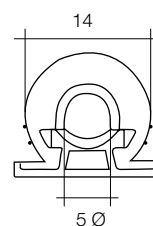
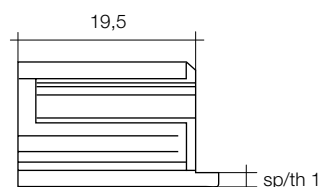
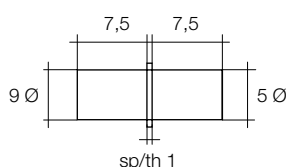
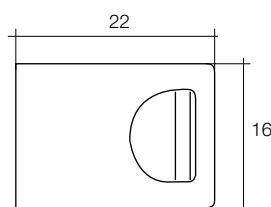

Code	min. order (nr)	qty/box (nr)
242/L	1000	1000
245/M	5000	5000

**244/L**

Reggipiano tondo in metallo zincato, perno Ø 3 mm e Ø 5 mm.

Reggipiano tondo in metallo zincato, perno Ø 3 mm e Ø 5 mm.

Reggipiano tondo in metallo zincato, perno Ø 3 mm e Ø 5 mm.

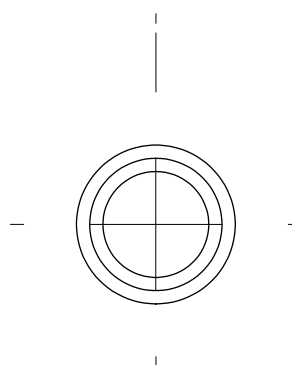
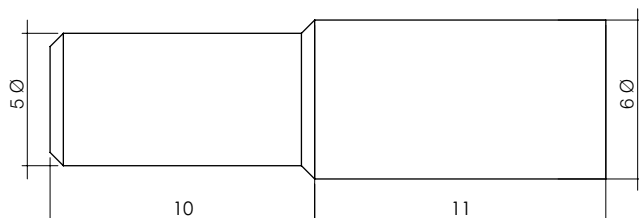

Code	min. order (nr)	qty/box (nr)
244/L	5000	5000

**REGGIPIANI E BLOCCARIPIANI**

SHELF

SUPPORTS DE PLAN ET TAQUETS POUR ÉTAGÈRE

**245/M**

Reggipiano tondo in metallo con flangia, perno Ø 5 mm. Finiture disponibili: nichelato, ottonato, bronzato.

Reggipiano tondo in metallo con flangia, perno Ø 5 mm. Finiture disponibili: nichelato, ottonato, bronzato.

Reggipiano tondo in metallo con flangia, perno Ø 5 mm. Finiture disponibili: nichelato, ottonato, bronzato.

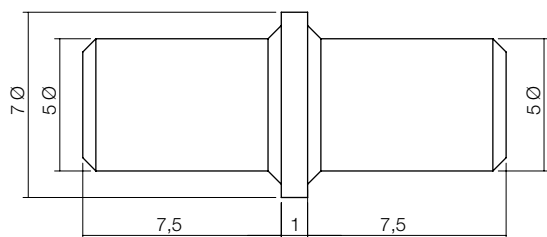

Code	min. order (nr)	qty./box (nr)
245/M	5000	5000

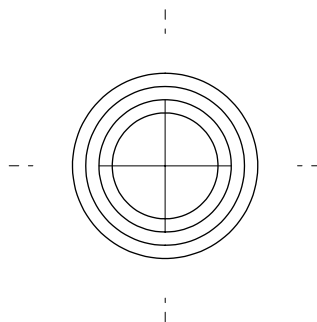
**250**

Reggipiano a paletta in metallo, perno Ø 3,5 mm. Finiture disponibili: nichelato, ottonato, bronzato.

Reggipiano a paletta in metallo, perno Ø 3,5 mm. Finiture disponibili: nichelato, ottonato, bronzato.

Reggipiano a paletta in metallo, perno Ø 3,5 mm. Finiture disponibili: nichelato, ottonato, bronzato.

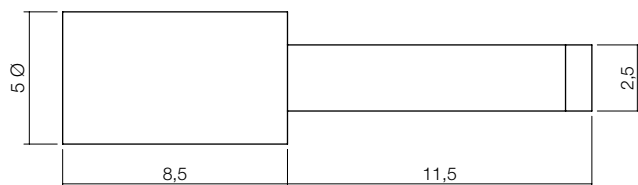

Code	min. order (nr)	qty./box (nr)
250	5000	5000

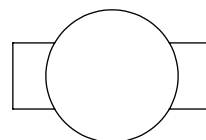
**248**

Reggipiano tondo in nylon o polietilene con testa Ø 8 mm e perno Ø 5 mm.

Reggipiano tondo in nylon o polietilene con testa Ø 8 mm e perno Ø 5 mm.

Reggipiano tondo in nylon o polietilene con testa Ø 8 mm e perno Ø 5 mm.

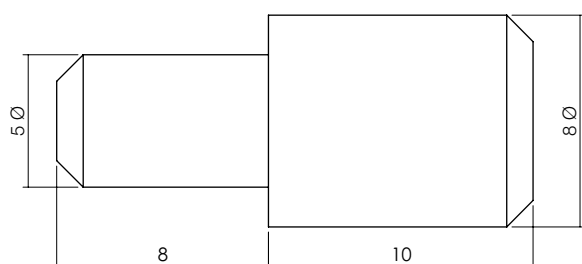

Code	min. order (nr)	qty./box (nr)
248	5000	5000

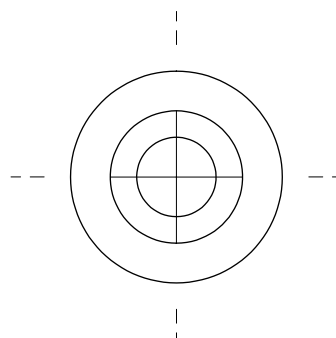

**REGGIPIANI E BLOCCARIPIANI**

SHELF

SUPPORTS DE PLAN ET TAQUETS POUR ÉTAGÈRE

**516**

Reggipiano in nylon ad innesto, completo di perno in metallo, art. 245/M.

Nylon slot-in shelf support, complete with metal pin, Art. 245/M.

Support de plan en nylon, à emboîtement, complété par un goujon en métal, art. 245/M.

Code	min. order (nr)	qty/box (nr)
516	5000	5000
245/M	5000	5000

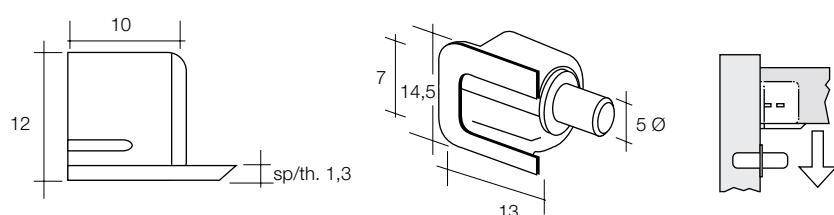
**512/P**

Reggipiano in nylon con perno Ø 5 mm e foro per vite.

Nylon shelf support with Ø 5 mm pin and screw hole.

Support de plan en nylon avec goujon Ø 5 mm et orifice pour vis.

Code	min. order (nr)	qty/box (nr)
512/P	5000	5000

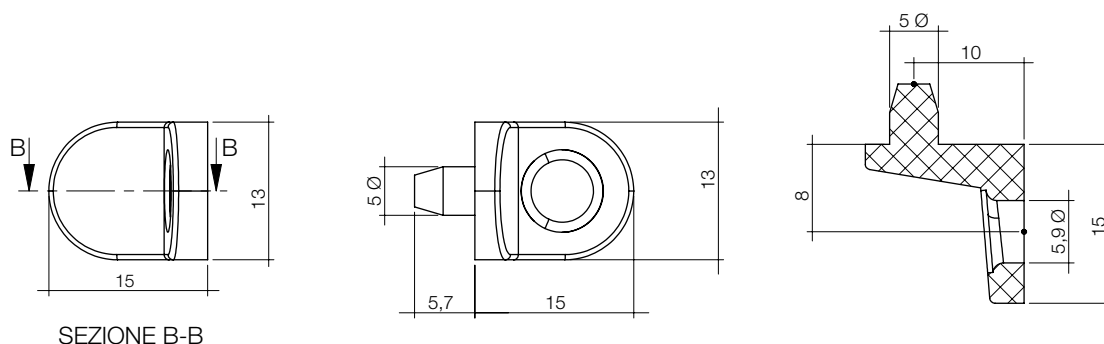

SEZIONE B-B

**512**

Reggipiano in zama con perno Ø 5 mm e foro per vite. Finiture disponibili: nichelato e bronzato.

Zamak shelf support with Ø 5 mm pin and screw hole. Available finishes: nickel-plated and bronzed.

Support de plan en Zamak avec goujon Ø 5 mm et orifice pour vis. Finitions disponibles: nickelé et bronzé.

Code	min. order (nr)	qty/box (nr)
512	5000	5000

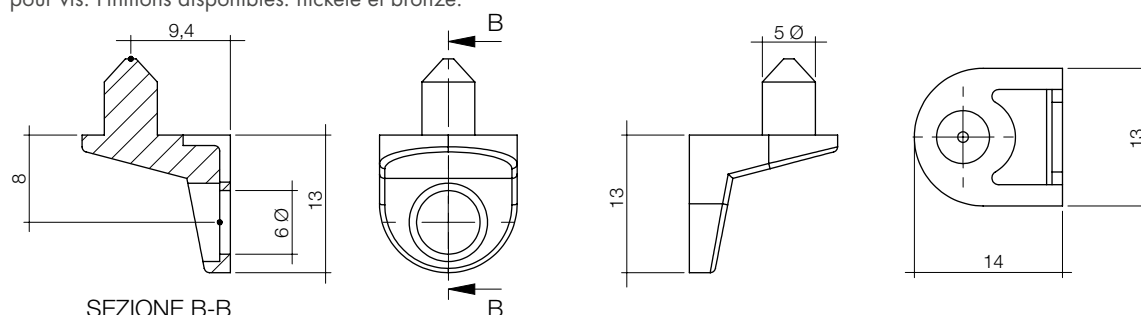

SEZIONE B-B

**REGGIPIANI E BLOCCARIPIANI**

SHELF

SUPPORTS DE PLAN ET TAQUETS POUR ÉTAGÈRE

**515**

Reggipiano in zama con perno Ø 5 mm sulla base d'appoggio.  
Finiture disponibili: nichelato e bronzato.

Zamak shelf support with Ø 5 mm pin on the support base.  
Available finishes: nickel-plated and bronzed.

Support de plan en Zamak avec goujon Ø 5 mm sur la base  
d'appui. Finitions disponibles: nickelé et bronzé.

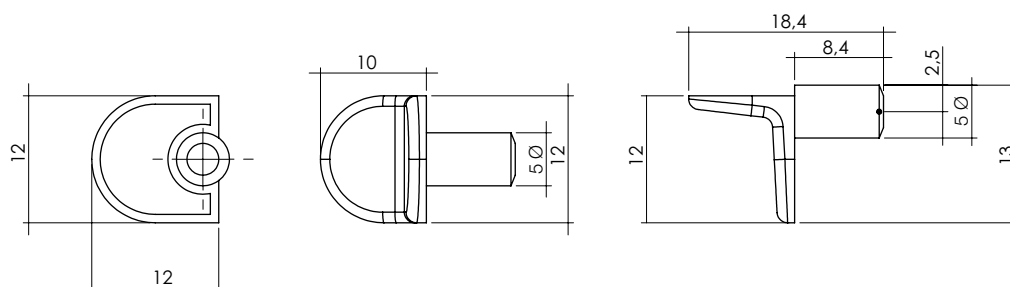

Code	min. order (nr)	qty/box (nr)
515	5000	5000

**521**

Reggipiano in zama con perno Ø 5 mm e piano d'appoggio avanzato. Finiture disponibili: nichelato e bronzato.

Zamak shelf support with Ø 5 mm pin and advanced support surface. Available finishes: nickel-plated and bronzed.

Support de plan en Zamak avec goujon Ø 5 mm et plan  
d'appui avancé. Finitions disponibles: nickelé et bronzé.

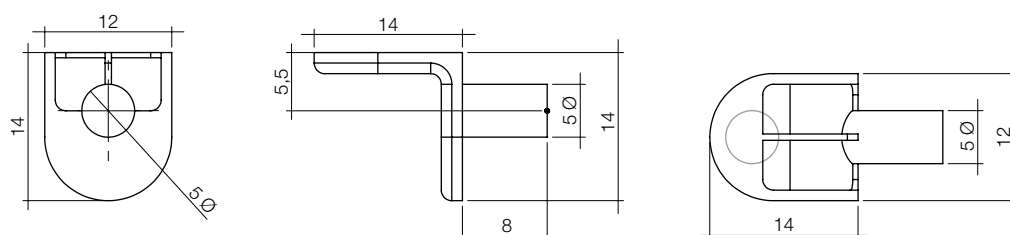

Code	min. order (nr)	qty/box (nr)
521	5000	5000

**521/2**

Reggipiano in zama con due perni di Ø 5 mm e piano d'appoggio avanzato. Finiture disponibili: nichelato e bronzato.

Zamak shelf support with two Ø 5 mm pins and advanced support surface. Available finishes: nickel-plated and bronzed.

Support de plan en Zamak avec deux goujons de Ø 5 mm et  
plan d'appui avancé. Finitions disponibles: nickelé et bronzé.

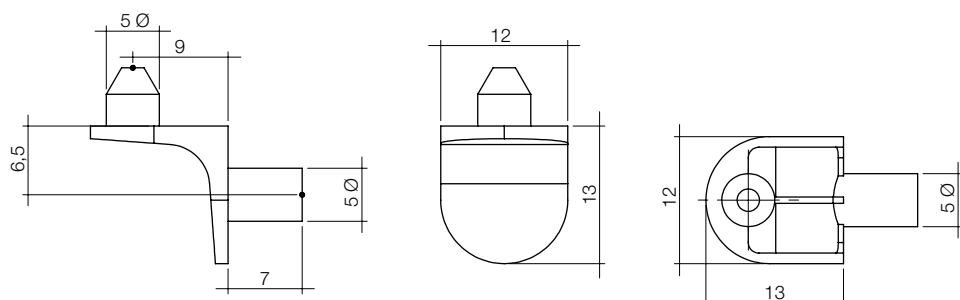

Code	min. order (nr)	qty/box (nr)
521/2	5000	5000

**REGGIPIANI E BLOCCARIPIANI**

SHELF

SUPPORTS DE PLAN ET TAQUETS POUR ÉTAGÈRE

**530**

Reggipiano anteriore a C in policarbonato trasparente per piani con spessore 16 e 18 mm. Perno art. 245 Ø 5 mm.

C-shaped transparent polycarbonate front shelf support for 16 and 18mm thick tops. Pin art. 245 Ø 5 mm.

Support de plan antérieur en forme de C en polycarbonate transparent pour plans d'épaisseur 16 et 18 mm. Goujon art. 245 Ø 5 mm.

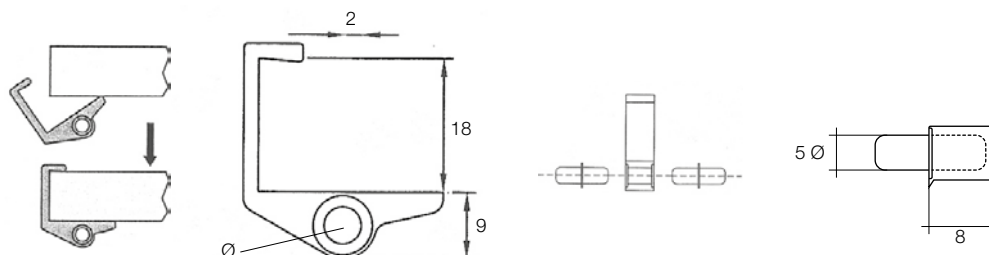

Code	min. order (nr)	qty/box (nr)
530	10000	10000

**535**

Reggipiano posteriore in policarbonato trasparente. Perno art. 245 Ø 5 mm.

Transparent polycarbonate back shelf support. Pin art. 245 Ø 5 mm.

Support de plan postérieur en polycarbonate transparent. Goujon art. 245 Ø 5 mm.

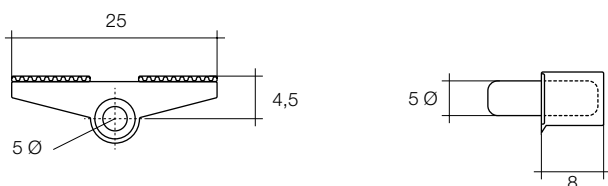

Code	min. order (nr)	qty/box (nr)
535	10000	10000

**243**

Reggipiano in gomma a ventosa, completo di perno Art. 244/L smontato. Colori disponibili: trasparente, bianco, marrone, nero.

Sucker rubber shelf support, complete with pin Art. 244/L disassembled. Colors available: transparent, white, brown, black.

Support de plan en caoutchouc à ventouse, complété par un goujon Art. 244/L démonté. Coloris disponibles : transparent, blanc, marron, noir.

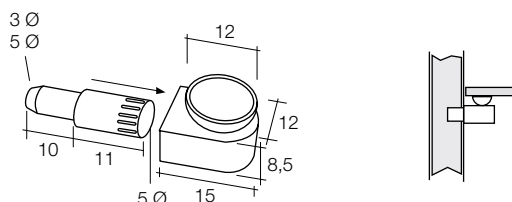

Code	min. order (nr)	qty/box (nr)
243	3000	3000

**REGGIPIANI E BLOCCARIPIANI**

SHELF

SUPPORTS DE PLAN ET TAQUETS POUR ÉTAGÈRE

**513/P**

Supporto reggi ripiani e ferma ripiani in zama, perno Ø 5 mm, per piani in vetro fino a 8 mm. Finiture: nichelato.

Shelf holder support and shelf stopper in zamak, Ø 5 mm pin, for glass shelves up to 8mm thick. Finishes: nickel-plated.

Support de tablettes et arrêt de tablettes en Zamak, goujon Ø 5 mm, pour plans en verre jusqu'à 8 mm. Finitions: nickelé.

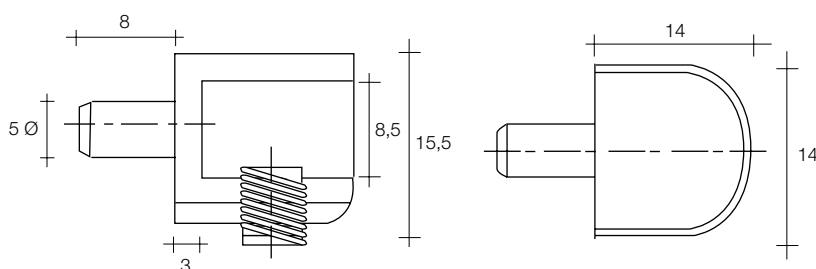

Code	min. order (nr)	qty/box (nr)
513/P	2000	2000

**513/P/CF**

Supporto reggi ripiani e ferma ripiani in zama con foro Ø 4,5 mm per fissaggio di piani in vetro fino a 8 mm di spessore. Finiture: nichelato.

Shelf holder support and shelf stopper in zamak with Ø 4,5mm hole for fixing glass tops up to 8mm thick. Finishes: nickel-plated.

Support de tablettes et arrêt de tablettes en Zamak avec orifice Ø 4,5 mm pour fixation de plans en verre jusqu'à 8 mm d'épaisseur. Finitions: nickelé.

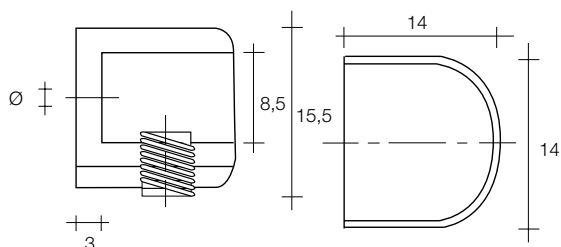

Code	min. order (nr)	qty/box (nr)
513/P/CF	2000	2000

**528**

Reggipiano in zama per vetri fino a 22 mm. Completo di linguetta di bloccaggio estraibile (sgancio a pulsante), Ø 5 mm. Finiture: nichelato.

Zamak shelf support for glass up to 22 mm. Complete with removable locking tab (button release), Ø5mm. Finishes: nickel-plated.

Support de plan en Zamak pour verres jusqu'à 22 mm. Ensemble de languettes de blocage amovibles (déblocage à bouton), Ø 5 mm. Finitions: nickelé.

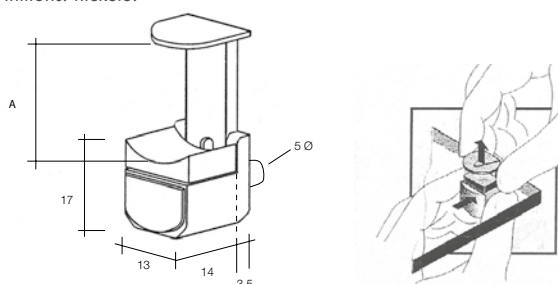

Code	A	min. order (nr)	qty/box (nr)
528	4-10	1000	1000
528/A	14-22	1000	1000
528/B	10-14	1000	1000

**REGGIPIANI E BLOCCARIPIANI**

SHELF

SUPPORTS DE PLAN ET TAQUETS POUR ÉTAGÈRE

**529**

Reggipiano a cono in policarbonato trasparente, per vetri di spessore 4 mm e 5 mm, con perno Ø 5 mm.

Cone-shaped shelf support in transparent polycarbonate, for 4 mm and 5 mm thick glass, with Ø 5 mm pin.

Support de plan en forme de cône en polycarbonate transparent, pour verres d'épaisseur 4 mm et 5 mm, avec goujon Ø 5 mm.

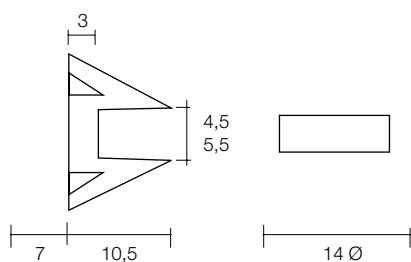

Code	min. order (nr)	qty/box (nr)
529	5000	5000

**534**

Reggipiano in policarbonato trasparente con perno Ø 5 mm, per vetri di spessore 4 mm e 5 mm.

Transparent polycarbonate shelf support with Ø 5 mm pin, for 4 mm and 5 mm thick glass.

Support de plan en polycarbonate transparent avec goujon Ø 5 mm, pour verres d'épaisseur 4 mm et 5 mm.

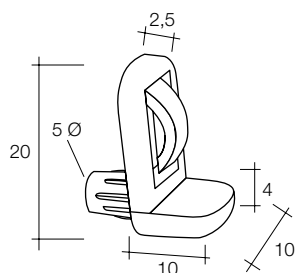

Code	min. order (nr)	qty/box (nr)
534	5000	5000

**337**

Fermapipiano in nylon a X, per posizioni multiple.

X-shaped nylon shelf-stopper, for multiple positions.

Arrêt pour plan, multiposition, en nylon, en forme de X.

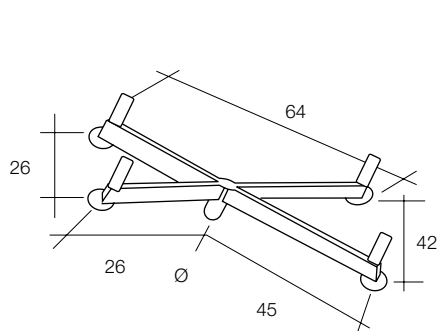

Code	min. order (nr)	qty/box (nr)
337	4000	4000
337/5	4000	4000

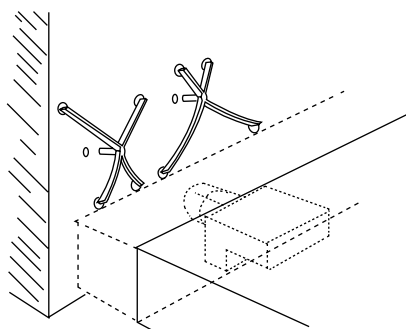

## REGGIPIANI E BLOCCARIPIANI

SHELF

SUPPORTS DE PLAN ET TAQUETS POUR ÉTAGÈRE

### 531

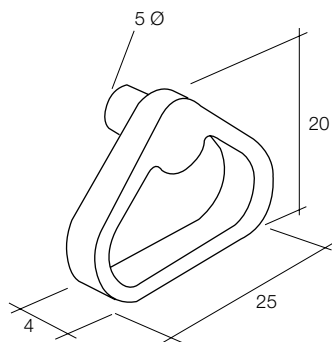
Fermaripiano in polietilene con perno  $\varnothing$  5 mm.Polyethylene shelf-stopper with  $\varnothing$  5 pin.Arrêt pour plan en polyéthylène avec goujon  $\varnothing$  5 mm.

Code	min. order (nr)	qty/box (nr)
531	5000	5000

### 536

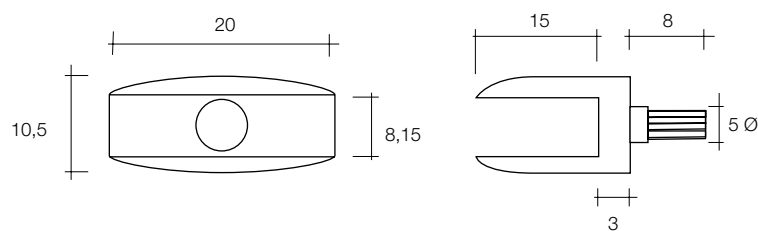
Reggipiano in policarbonato trasparente con perno  $\varnothing$  5 mm, per vetri di spessore 6 mm.Transparent polycarbonate support shelf with  $\varnothing$  5 mm pin, for 6 mm thick glass.Support de plan en polycarbonate transparent avec goujon  $\varnothing$  5 mm, pour verres d'épaisseur 6 mm.

Code	min. order (nr)	qty/box (nr)
536	5000	5000





**PARACOLPI E CRICCHETTI**  
STRIKE PROTECTORS AND RATCHETS  
TAMPONS AMORTISSEURS ET CLIQUETS

**PARACOLPI E CRICCHETTI**STRIKE PROTECTORS AND RATCHETS  
TAMPONS AMORTISSEURS ET CLIQUETS**PARACOLPI ADESIVI STANDARD**

Paracolpi adesivi trasparenti standard emisferici in placchette.

Standard hemispheric transparent adhesive strike protectors

Tampons amortisseurs adhésifs, transparents, standards, hémisphériques fournis en plaque.

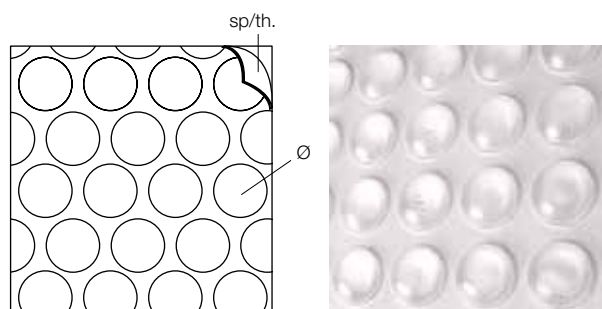

Code	A	B	min. order (nr)	qty/box (nr)
217	7	1,5	10000	10000
217/B	8	1,6	10000	10000
217/08	8	2,2	8000	8000
218	10	1,5	10000	10000
219	10	3	5000	5000
219/A	11	5	4015	4015
219/B	13	7,5	2000	2000
219/C	16	8	1600	1600
219/D	19	9,5	1008	1008

**PARACOLPI ADESIVI CILINDRICI**

Paracolpi adesivi trasparenti cilindrici in placchette.

Cylindrical transparent adhesive strike protectors

Tampons amortisseurs adhésifs, transparents, cylindriques, fournis en plaque.

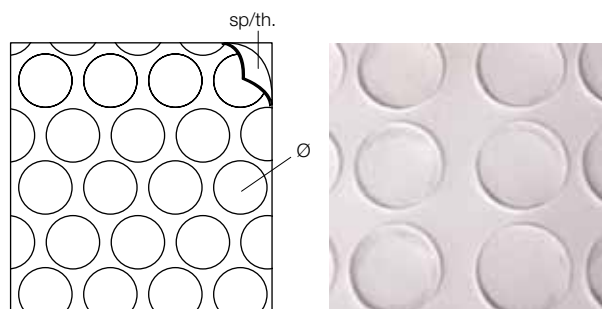

Code	A	B	min. order (nr)	qty/box (nr)
218/01	10	1	10000	10000
218/18	18	1	3600	3600
216	13	4	4000	4000
216/A	20	6,2	1407	1407
216/B	16,5	10,2	1280	1280
216/C	22,3	10,1	702	702

**PARACOLPI ADESIVI QUADRATI**

Paracolpi adesivi trasparenti quadrati in placchette.

Square transparent adhesive strike protectors

Tampons amortisseurs adhésifs, transparents, carrés fournis en plaque.

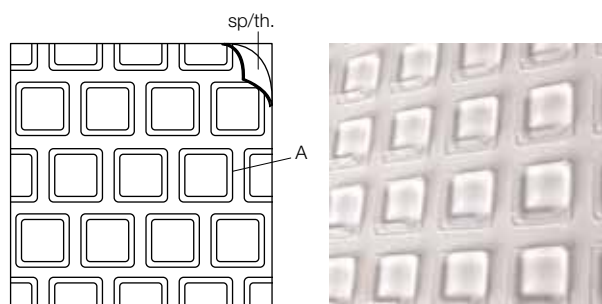

Code	A	B	C	min. order (nr)	qty/box (nr)
214/10	10	10	2,5	7700	7700
214/13	12,5	12,5	5,8	4000	4000
214/20A	20,5	20,5	7,5	1008	1008
214/20B	20,5	20,5	13,2	504	504

## PARACOLPI E CRICCHETTI

### STRIKE PROTECTORS AND RATCHETS

### TAMPONS AMORTISSEURS ET CLIQUETS

#### 221 Ø 8

Paracolpi ammortizzatore bi-materia con gambo rigido Ø 8 mm e testa in gomma.

Bi-material shock-absorbing strike protector with Ø 8 mm rigid shank and rubber head.

Tampons amortisseurs bi-matière avec pied rigide Ø 8 mm et tête en caoutchouc.

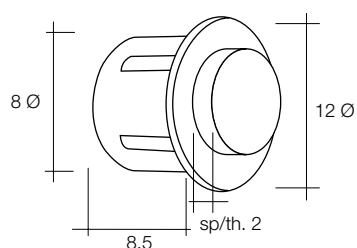

Code	min. order (nr)	qty./box (nr)
221	5000	5000

#### 221 Ø 10

Paracolpi ammortizzatore bi-materia con gambo rigido Ø 10 mm e testa in gomma.

Bi-material shock-absorbing strike protector with Ø 10 mm rigid shank and rubber head

Tampons amortisseurs bi-matière avec pied rigide Ø 10 mm et tête en caoutchouc.

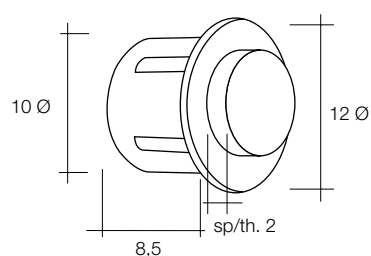

Code	min. order (nr)	qty./box (nr)
221	5000	5000

#### 224

Paracolpo a pressione in gomma, morbido, testa concava liscia, gambo Ø 5 mm.

Soft rubber pressure strike protector, smooth concave head, shank Ø 5 mm.

Tampón amortisseur à pression en caoutchouc, souple, tête concave lisse, pied Ø 5 mm.

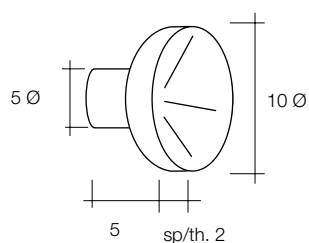

Code	min. order (nr)	qty./box (nr)
224	5000	5000

**PARACOLPI E CRICCHETTI**STRIKE PROTECTORS AND RATCHETS  
TAMPONS AMORTISSEURS ET CLIQUETS**226**

Paracolpo morbido in gomma con gambo Ø 5 mm e testa zigrinata.

Soft rubber strike protector with Ø 5 mm shank and knurled head.

Tampon amortisseur souple en caoutchouc avec pied Ø 5 mm et tête moletée.

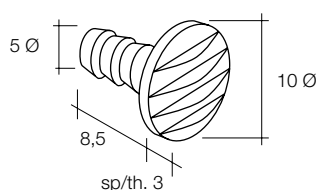

Code	min. order (nr)	qty/box (nr)
226	5000	5000

**226/TL**

Nuovo paracolpi bi-materia con gambo Ø 5 mm e sottotesta rigidi, testa liscia in gomma. Particolarmente adatto per l'inserimento con macchine automatiche. Colori: gambo: neutro testa: neutro, grigio chiaro, grigio antracite

New bi-material strike protector with Ø 5 mm shank and rigid underheads, smooth rubber head. Particolarmente adatto per l'inserimento con macchine automatiche. Colori: gambo: neutro testa: neutro, grigio chiaro, grigio antracite

Nouveaux tampons amortisseurs bi-matière avec pied Ø 5 mm et sous tête rigides, tête lisse en caoutchouc. Particolarmente adatto per l'inserimento con macchine automatiche. Colori: gambo: neutro testa: neutro, grigio chiaro, grigio antracite

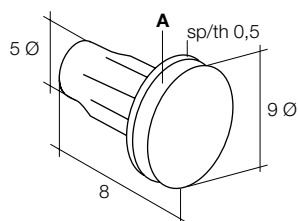

Code	A	min. order (nr)	qty/box (nr)
226/TL/B	1,3	5000	5000
226/TL	2	5000	5000

**PARACOLPI E CRICCHETTI**

STRIKE PROTECTORS AND RATCHETS  
TAMPONS AMORTISSEURS ET CLIQUETS

**301 - 301/P**

Cricchetto a scatto 40 mm con paracolpo. Art. 301: fissaggio con basetta a vite. Art. 301/P: fissaggio con basetta con perni Ø 8 mm.

40 mm snap ratchet with strike pad. Art. 301: fixing with screw plate. Art.301/P: fixing with plate with Ø8mm pins.

Cliquet à dé clic 40 mm avec tampon amortisseur. Art. 301: fixation avec plaque à vis. Art. 301/P : fixation avec plaque avec goujons Ø 8 mm.

Code	min. order (nr)	qty/box (nr)
301	50	50
301/P	50	50

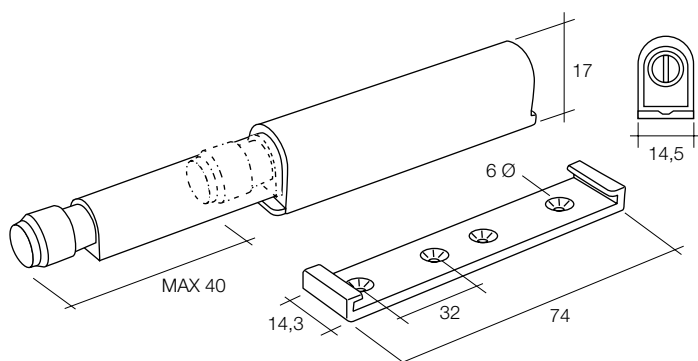
**301/P/C4B**

Push-pull ad incasso regolabile 3 mm, con paracolpo. Corsa 40 mm, con basetta di fissaggio.

3mm adjustable built-in push-pull with strike pad. 40 mm stroke, with fixing plate.

Va-et-vient à emboîtement réglable 3 mm avec tampon amortisseur. Course 40 mm, avec plaque de fixation.

Code	min. order (nr)	qty/box (nr)
301/P/C4B	100	100

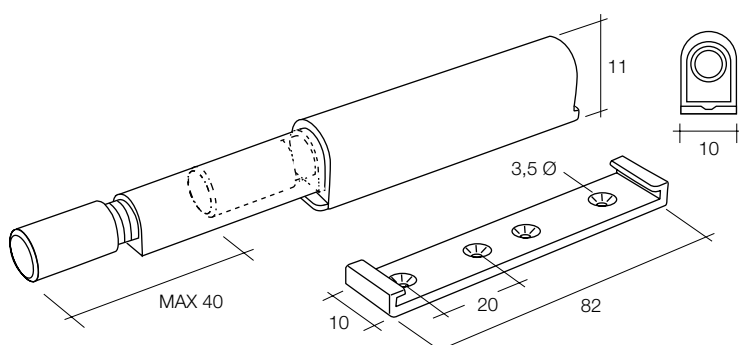

**PARACOLPI E CRICCHETTI**

STRIKE PROTECTORS AND RATCHETS  
TAMPONS AMORTISSEURS ET CLIQUETS

**302 - 302/C**

Push-pull ad incasso regolabile 3 mm, con paracolpo (C) o con magnete. Corsa 16 mm. Disponibile anche la versione con basetta di fissaggio.

3mm adjustable built-in push-pull with strike pad (C) or magnet. 16 mm stroke. Also in version with fixing plate.

Va-et-vient à emboîtement réglable 3 mm avec tampon amortisseur (C) ou avec aimant. Course 16 mm. Disponible aussi en version avec plaque de fixation.

Code	min. order (nr)	qty/box (nr)
302	100	100
302/C	100	100

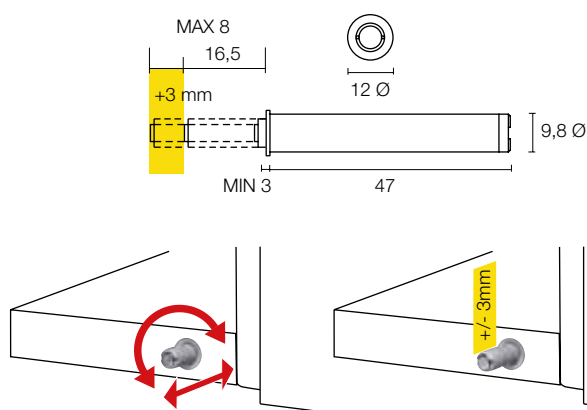
**303 - 303/C**

Push-pull ad incasso con magnete (C) o con paracolpo. Corsa 40 mm.

Built-in push-pull with magnet (C) or with strike pad. 40 mm stroke.

Va-et-vient à emboîtement avec aimant (C) ou avec tampon amortisseur. Course 40 mm.

Code	min. order (nr)	qty/box (nr)
303	100	100
303/C	100	100

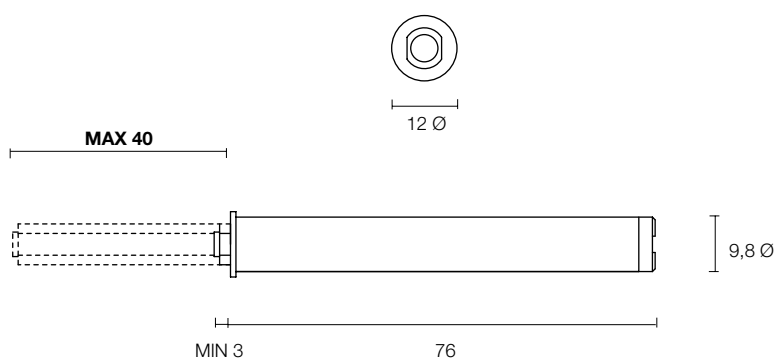

**PARACOLPI E CRICCHETTI**

STRIKE PROTECTORS AND RATCHETS  
TAMPONS AMORTISSEURS ET CLIQUETS

**303/R - 300/R/C**

Push-pull ad incasso regolabile 3 mm con magnete (C) o con paracolpo. Corsa 36 mm. Anche in versione con basetta di fissaggio a mezzo viti.

3mm adjustable built-in push-pull with magnet (C) or with strike pad. 36mm stroke. Also in the version with screw-fixed base.

Va-et-vient à emboîtement réglable 3 mm avec aimant (C) ou avec tampon amortisseur. Course 36 mm. Aussi en version avec plaque de fixation à l'aide de vis.

Code	min. order (nr)	qty/box (nr)
303/R	100	100
303/R/C	100	100

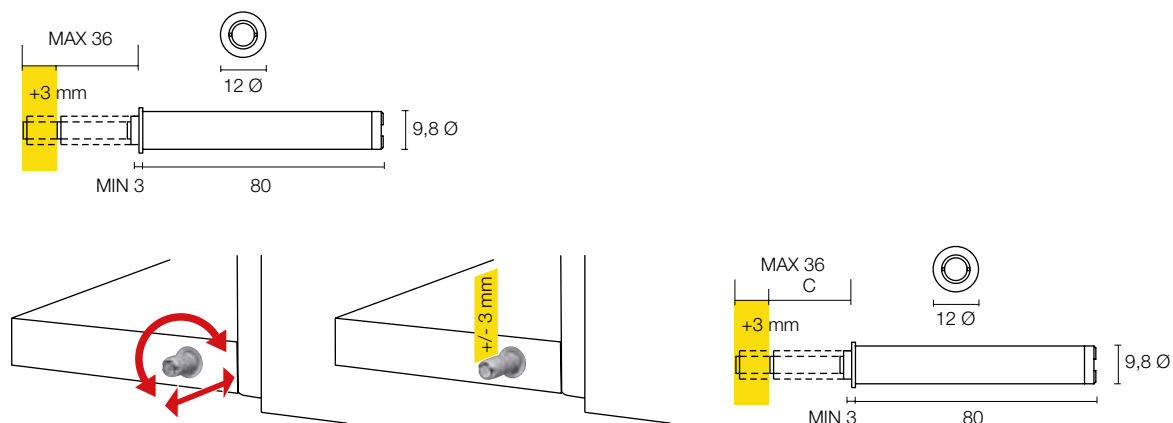
**306**

Cricchetto ferma ante automatico in nylon con piastrino di fermo. Adatto ad ante pesanti.

Nylon automatic door stopping ratchet with stop plate. Ideal for heavy door.

Cliquet d'entrebâillement automatique en nylon avec plaque d'arrêt. Adapté aux portes lourdes.

Code	min. order (nr)	qty/box (nr)
306	250	250

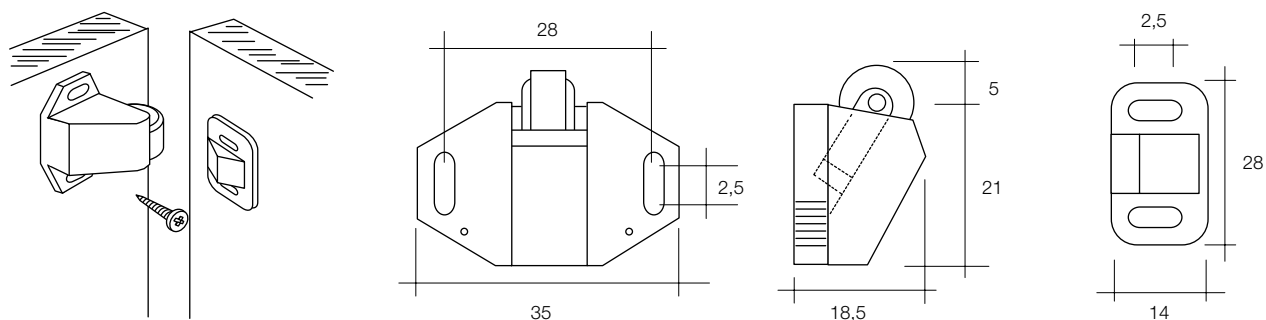

**PARACOLPI E CRICCHETTI**

STRIKE PROTECTORS AND RATCHETS

TAMPONS AMORTISSEURS ET CLIQUETS

**307**

Cricchetto ferma ante automatico in nylon e metallo zincato con piastrino di fermo. Adatto ad ante pesanti.

Nylon and galvanized metal automatic door stopping ratchet with stop plate. Ideal for heavy door.

Cliquet d'entrebâillement automatique en nylon et galvanisé, avec plaque d'arrêt. Adapté aux portes lourdes.

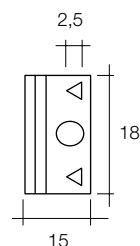
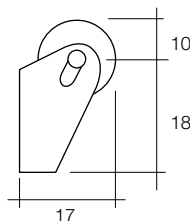
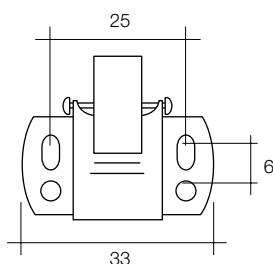
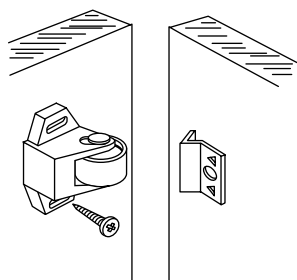

Code	min. order (nr)	qty/box (nr)
307	100	100

**308**

Serratura a scatto automatica, in metallo e nylon, con viti di fissaggio. Confezionata singolarmente.

Automatic snap lock, in metal and nylon with fixing screws. Individually packaged.

Serrure à dé clic automatique, en métal et en nylon, avec vis de fixation. Emballée individuellement.

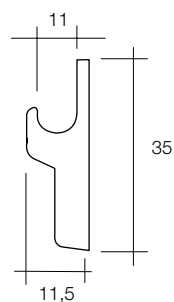
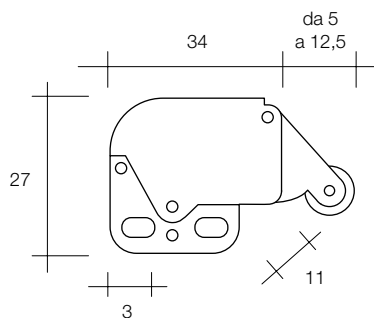
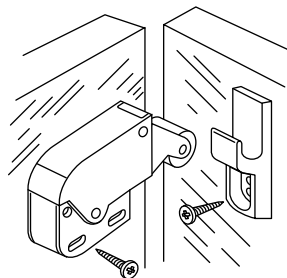

Code	min. order (nr)	qty/box (nr)
308	100	100

**312**

Cricchetto a rullo sostegno ante, fissaggio con perni Ø 5 mm.

Cricchetto a rullo sostegno ante, fissaggio con perni Ø 5 mm.

Cricchetto a rullo sostegno ante, fissaggio con perni Ø 5 mm.

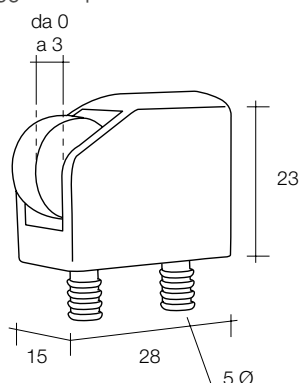
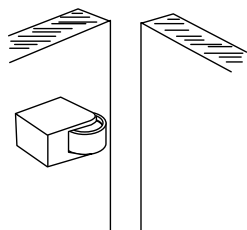

Code	min. order (nr)	qty/box (nr)
312	500	500

**COPRIVITI E COPRIFORI**  
COVERS  
CACHE-VIS ET CACHE-ORIFICES

## COPRIVITI E COPRIFORI

COVERS

CACHE-VIS ET CACHE-ORIFICES

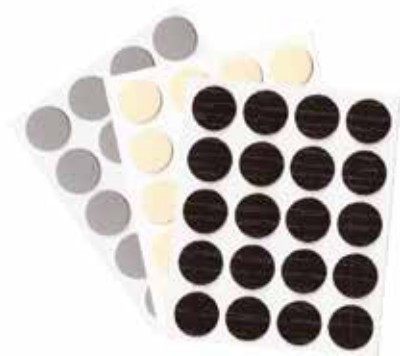
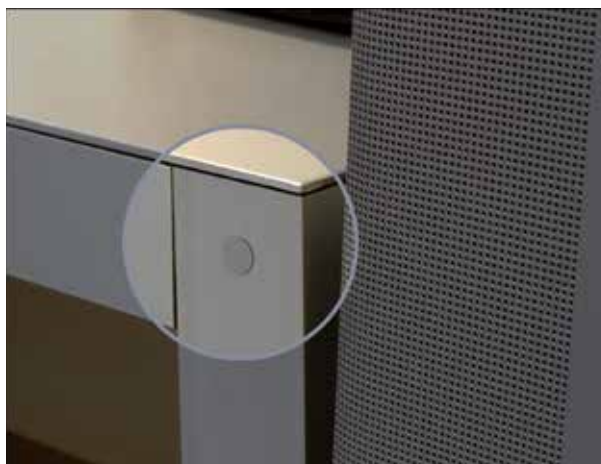

Le placche standard, di copriviti, sono fornite in scatole dedicate. Su richiesta, il prodotto è realizzabile in qualsiasi dimensione, in rotoli o placchette con quantità a richiesta.

Standard plates for screw covers are supplied in dedicated boxes. On request the product can be made in any size, in rolls or plates with quantities on request.

Les plaques standard de cache-vis sont fournies dans des boîtes spéciales. Sur demande, le produit peut être réalisé dans n'importe quelle taille, en rouleau ou plaque dans la quantité demandée.

## COPRIVITI PERSONALIZZABILI

CUSTOMIZABLE HOLE COVERS. - CACHE - VIS PERSONNALISABLES

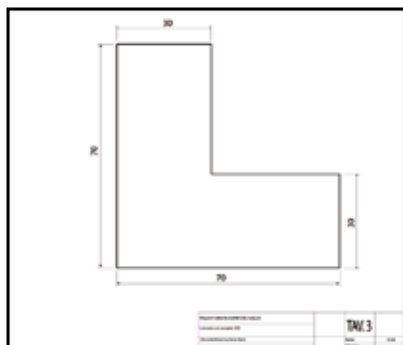



























































Su richiesta del cliente i copriviti possono essere realizzati in qualsiasi colore, forma e dimensione.

On request can be made in any colours, shape and dimension.

Sur demande on peut fabriquer les cache-vis dans n'importe quelle couleur, forme et taille.

**COPRIFORO ADESIVI - COLORI DISPONIBILI**  
 ADHESIVE HOLE COVERS - RANGE OF COLOURS  
 CACHE-TROU EN PLASTIQUE - COULEURS DISPONIBLES

 Acero Acer 257	 Acero Acer 277plr2	 Acero Acer 2128	 Betulla Birch 258	 Betulla Birch 260
 Betulla Birch 3116	 Ciliegio Cherry 9019	 Ciliegio Cherry 9030	 Ciliegio Cherry 9049	 Ciliegio Cherry 9117
 Ciliegio Cherry 9118	 Ciliegio Cherry 9154	 Ciliegio Cherry 9161	 Faggio Beech 374	 Frassino Ash 168
 Larice Larch 6905	 Larice Larch 9136	 Limba Limba 291plr2	 Limba Limba 292plr2	 Limba Limba c29plr2
 Magnolia Magnolia 93622	 Marmo Marble 12081	 Marmo Marble 12082	 Marmo Marble 12083	 Mogano Mahogany 988
 Nocciola Hazelnut 5483	 Noce Walnut 6045	 Noce Walnut 6074plr2	 Noce Walnut 6077	 Noce Walnut 6078
 Noce Walnut 6080plr2	 Noce Walnut 6198	 Olmo Elm D36	 Olmo Elm 4742	 Olmo Elm 4805
 Olmo Elm 4833	 Olmo Elm 40037	 Olmo Elm 40038	 Olmo Elm 40039	 Olmo Elm 40040
 Pero Pear Tree 577	 Pino Pine 282	 Pino Pine 283	 Pino Pine 2102	 Pino Pine 63003plr2
 Rovere Oak 4501	 Rovere Oak 4548	 Rovere Oak 4557	 Rovere Oak 4569	 Rovere Oak 4583plr2
 Rovere Oak 4647	 Rovere Oak 4648	 Rovere Oak 4663	 Rovere Oak 4686	 Rovere Oak 4692
 Rovere Oak 4731	 Rovere Oak 4753	 Rovere Oak 4808	 Rovere Oak 4819	 Rovere Oak 4832
 Rovere Oak 4843	 Rovere Oak 4858	 Rovere Oak 4971	 Rovere Oak 40041	 Rovere Oak 40203

**COPRIFORO ADESIVI - COLORI DISPONIBILI**  
 ADHESIVE HOLE COVERS - RANGE OF COLOURS  
 CACHE-TROU EN PLASTIQUE - COULEURS DISPONIBLES





















	Rovere Oak 40215plr2		Rovere Oak 40278plr2		Rovere Oak 40365		Rovere Oak 40368		Sicomoro Sycamore 727
	Teak Teak 1112		Tela Fabric 21223		Tela Fabric 21291		Tiglio Linden 1052		Tiglio Linden 1509
	Tortora Grey Beige 588plr2		Tortora Grey Beige 5107		Tortora Grey Beige 5191		Tortora Grey Beige 5202		Tortora Grey Beige 5203
	Tortora Grey Beige 5264		Trama Grid 21115		Trama Grid 51116		Trama Grid 51117		Trama Grid 51132
	Trama Grid 51133		Trama Grid 51134		Wengè Wengè 994plr2		Wengè Wengè 9005		Wengè Wengè 90033
	Zebrano Zebra wood 7004		Zebrano Zebra wood 70019plr2						

	Bianco White 11164		Bianco White 11164plr2		Bianco White 13744v		Bianco White 13759		Bianco White 13933
	Bianco White 13982		Bianco White 6762		Panna Cream 18052		Panna Cream 18056		Avorio Ivory 9833
	Avorio Ivory 9876		Grigio Grey 93520		Grigio Grey 93562		Grigio Grey 93562plr2		Grigio Grey 93873
	Grigio Grey 94052		Grigio Grey 94117		Grigio Grey 94121		Grigio Grey 94183		Grigio Grey 94186
	Grigio Grey 94191		Silver Silver 01		Alluminio Aluminium 93336		Allu Met Alu Met 06		Allu Met Alu Met 07
	Allu Met Alu Met 9368		Allu Sat Alu Sat 01		Cromato Chrome		Nero Black 657		Nero Black 657plr2

## COPRIFORO ADESIVI - COLORI DISPONIBILI

ADHESIVE HOLE COVERS - RANGE OF COLOURS

CACHE-TRou EN PLASTIQUE - COULEURS DISPONIBLES

 Nero Black 670	 Verniciabile Colourable	 Giallo Yellow 28411	 Giallo Yellow 28425	 Arancio Orange 30510
 Rosso Red 48948	 Rosso Red 48953	 Rosa Pink 6903	 Ciclamino Cyclamen 47345	 Lilla Lilac 47309
 Lilla Lilac 47309plr2	 Marrone Brown 205	 Marrone Brown 2633	 Blu Blue 66624	 Azzurro Light Blue 68782
 Verde Green 78513plr2	 Verde Green 78544	 Verde Green 78553	 Verde Green 78577	 Verde Green 78595
 Senape Mustard 28417				

**COPRIVITI E COPRIFORI**

COVERS

CACHE-VIS ET CACHE-ORIFICES

**191-192-192/16-193-194-194/30-194/35-194/40**

Coprivite adesivo con spessore ridotto, per copertura di viti, bussole, eccentrici. Disponibile in placchette o rotoli. Testa Ø 9/16/20/25/30/35/40 mm. Spessore 0,5 mm.

Reduced thickness adhesive cover to cover screws, bushings, eccentrics. Available in plates or rolls. Head Ø 9/16/20/25/30/35/40 mm. 0,5 mm thick.

Cache-vis adhésif d'épaisseur réduite, pour couvrir vis, douilles, excentriques. Disponible en plaque ou en rouleau. Tête Ø 9/16/20/25/30/35/40 mm. Épaisseur 0,5 mm.

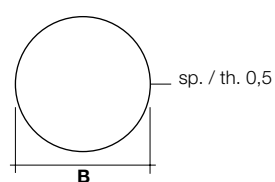

Code	B	min. order (nr)	qty/box (nr)
191	Ø 9	3000	3000
192	Ø 13	2000	2000
192/16	Ø 16	1000	1000
193	Ø 20	900	900
194	Ø 25	720	720
194/30	Ø 30	480	480
194/35	Ø 35	360	360
194/40	Ø 40	180	180

**195**

Coprivite per vite T.C.E.I., perno Ø 4 mm, testa Ø 13 mm.

Cover for T.C.E.I. Screw, pin Ø 4 mm, head Ø 13 mm.

Cache-vis pour vis T.C.E.I., goujon Ø 4 mm, tête Ø 13 mm.

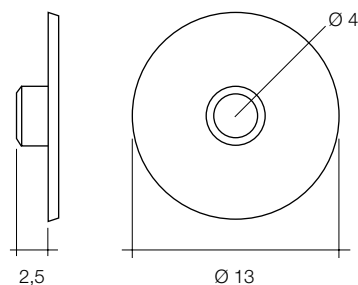

Code	min. order (nr)	qty/box (nr)
195	5000	5000

**196**

Coprivite con perno lungo Ø 3 - 4 mm e testa Ø 12 mm.

Screw cover with long pin Ø 3 - 4 mm head Ø 12 mm.

Cache-vis avec goujon long Ø 3 - 4 mm et tête Ø 12 mm.

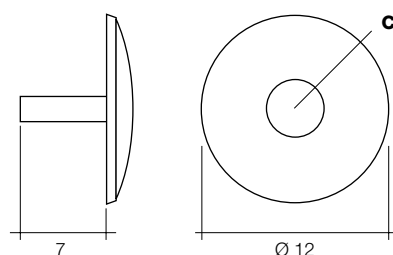

Code	c	min. order (nr)	qty/box (nr)
196	Ø 3	5000	5000
196	Ø 4	5000	5000

**COPRIVITI E COPRIFORI**

COVERS

CACHE-VIS ET CACHE-ORIFICES

**196/Q**

Coprivite con perno quadro e viti forate.

Screw cover with square pin for perforated screws.

Cache-vis avec goujon carré et vis à tête forée.

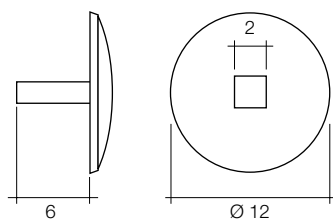

Code	min. order (nr)	qty/box (nr)
196/Q	5000	5000

**206**

Copri eccentrico Ø 17 mm con perno Ø 3x3 mm, 4x3-4-5 mm.

Ø 17 mm eccentric cover with Ø 3x3mm, 4x3-4-5 mm pin.

Cache-excentrique Ø 17 mm avec goujon Ø 3 x 3 mm, 4 x 3 - 4 - 5 mm.

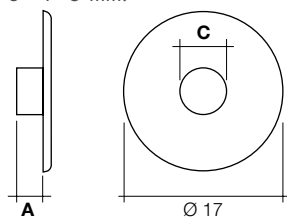

Code	A	C	min. order (nr)	qty/box (nr)
206	3	Ø 3	5000	5000
206	3	Ø 4	5000	5000
206	4	Ø 4	5000	5000
206	5	Ø 4	5000	5000

**COPRIVITI E COPRIFORI**

COVERS

CACHE-VIS ET CACHE-ORIFICES

**200**

Copriforo in plastica (misure e codici articolo come da schema).

Copriforo in plastica (misure e codici articolo come da schema).

Copriforo in plastica (misure e codici articolo come da schema).

**VERSIONE A**

gambo alto / high shank / pied haute

**VERSIONE B**

gambo basso / low shank / pied basse

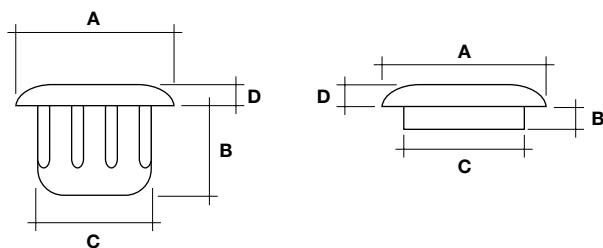

Code	A	B	C	D	min. order (nr)	qty/box (nr)
200/3	5	4	∅ 3	4	10000	10000
200/4	6	4	∅ 4	1	10000	10000
200/5	8	5	∅ 5	1	10000	10000
200/6	10	7	∅ 6	2	5000	5000
200/8	12	8	∅ 8	1	10000	10000
200/8/B	12	3	∅ 8	1	1000	1000
200/9	13	7	∅ 9	2	5000	5000
200/10/A	14	8	∅ 10	1,7	5000	5000
200/10/B	13	3	∅ 10	1	5000	5000
200/12/A	16	8	∅ 12	1,2	2500	2500
200/12/B	16	5	∅ 12	1,2	2500	2500
200/14/A	17	8	∅ 14	2	2500	2500
200/14/B	15,5	3	∅ 14	2	2500	2500
200/15/B	15,5	3	∅ 15	2	2500	2500
200/16/B	17	3	∅ 16	1,2	2500	2500

**200/NIK**

Copriforo in metallo nichelato con perno ∅ 5 mm e ∅ 3 mm.

Hole cover in nickel-plated metal with ∅ 5 mm pin and ∅ 3 mm.

Cache-orifice en métal nickelé avec goujon ∅ 5 mm et ∅ 3 mm.

Code	min. order (nr)	qty/box (nr)
200/NIK/05	5000	5000
200/NIK/03	5000	5000

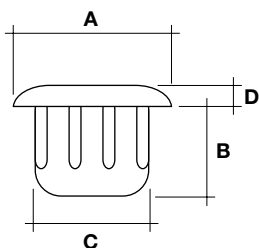

**ANGOLARI**  
CORNERS  
CORNIÈRES

**ANGOLARI**CORNERS  
CORNIÈRES**328**

Angolare rinforzato in nylon a 4 fori, con coperchio a pressione.

4-Hole nylon-reinforced corner, with pressure cover.

Cornière renforcée en nylon à 4 orifices, avec couvercle à pression.

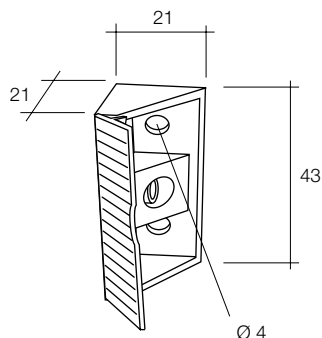

Code	min. order (nr)	qty./box (nr)
328	2000	2000

**333**

Angolare in nylon, con perno Ø 10 mm per fissaggio top e zoccolature.

Nylon corner, with Ø 10mm pin to fix tops and skirtings.

Cornière en nylon avec goujon Ø 10 mm pour fixation tops et plinthes.

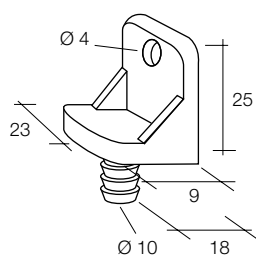

Code	min. order (nr)	qty./box (nr)
333	4000	4000

**334**

Angolare in nylon, con perno Ø 8 mm per fissaggio top e zoccolature.

Nylon corner, with Ø 8 mm pin to fix tops and skirtings.

Cornière en nylon avec goujon Ø 8 mm pour fixation tops et plinthes.

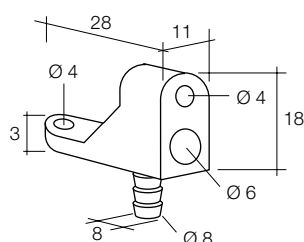

Code	min. order (nr)	qty./box (nr)
334	7000	7000

**ANGOLARI**CORNERS  
CORNIÈRES**335**

Angolare in nylon, con perno Ø 10 mm per fissaggio top e zoccolature.

Nylon corner, with Ø 10mm pin to fix tops and skirtings.

Cornière en nylon avec goujon Ø 10 mm pour fixation tops et plinthes.

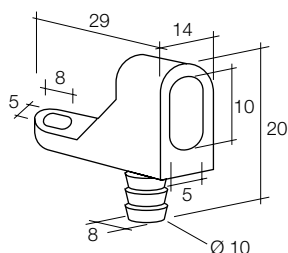

Code	min. order (nr)	qty/box (nr)
335	4000	4000

**336**

Angolare rinforzato in nylon zigrinato ferma frigo, senza perni. Fissaggio a pistola.

Knurled nylon - reinforced corner, fridge stopper, in nylon, without pins. Gun fixing.

Cornière renforcée d'arrêt réfrigérateur, en nylon moleté, sans goujon. Fixation au pistolet.

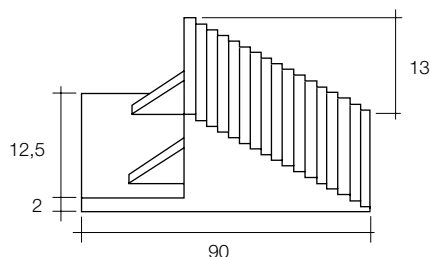

Code	min. order (nr)	qty/box (nr)
329/13	1000	1000

**339/L**

Angolare rinforzato in nylon universale, con perni Ø 10 mm e fori ad interasse 32 mm.

Corner reinforced with universal nylon, with pins Ø 10 mm and holes with 32 mm spacing.

Cornière renforcée en nylon universel, avec goujons Ø 10 mm et orofices à écartement 32 mm.

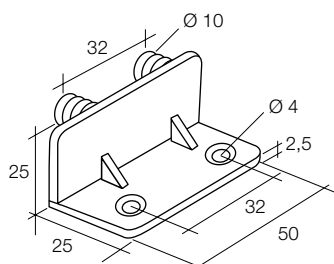

Code	min. order (nr)	qty/box (nr)
339/L	2000	2000



**PATTINI, FERMA SCHIENA,  
SPINE E GIUNTI**

SKIDS, BACK STOP, DOWELS AND JOINTS  
PATINS, ARRÊT ARRIÈRE, BROCHES ET JOINTS

**PATTINI**SKIDS  
PATINS**397**

Pattini in polietilene per basi, spessore 7 mm e perni Ø 8 mm.

Polyethylene shoes for bases, 7mm thick and Ø 8 mm pins.

Patins en polyéthylène pour bases, épaisseur 7 mm et goujons Ø 8 mm.

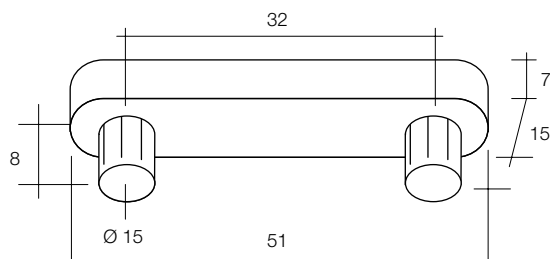

Code	min. order (nr)	qty/box (nr)
397	4000	4000

**398**

Pattini in polietilene per basi, spessore 3 mm e perni Ø 8 mm.

Polyethylene shoes for bases, 3mm thick and Ø 8 mm pins.

Patins en polyéthylène pour bases, épaisseur 3 mm et goujons Ø 8 mm.

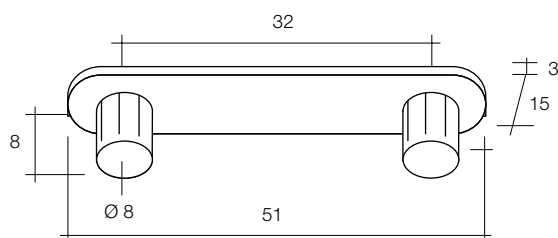

Code	min. order (nr)	qty/box (nr)
398	7000	7000

**FERMA SCHIENA**BACK STOP  
ARRÊT ARRIÈRE**408**

Fermaschiena ad angolo in polietilene con aletta e vite premontata 3,5x20.

Polyethylene corner back stopper with tab and 3.5x20 pre-fitted screw.

Arrêt arrière angulaire en polyéthylène avec ailette et vis prémontée 3,5x20.

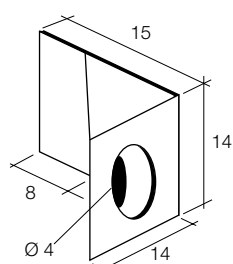

Code	min. order (nr)	qty/box (nr)
408	5000	5000

**SPINE**DOWELS  
BROCHES**417**

Spina in nylon Ø 8 mm.

Ø 8 mm nylon plug.

Broche en nylon Ø 8 mm.

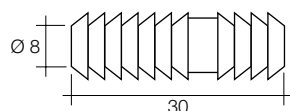

Code	min. order (nr)	qty/box (nr)
417	2000	2000

**GIUNTI**JOINTS  
JOINTS**750**

Giunto ad incastro in makrolon nero o bianco, in due pezzi, con 4 fori svasati, per assemblaggio frontale dei rivestimenti in legno.

Interlocking black or white makrolon joint, in two pieces, with 4 countersunk holes, for front assembly of wood panelling.

Joint à insérer en Makrolon noir ou blanc, en deux pièces, avec 4 orifices évasés, pour assemblage frontal des revêtements en bois.

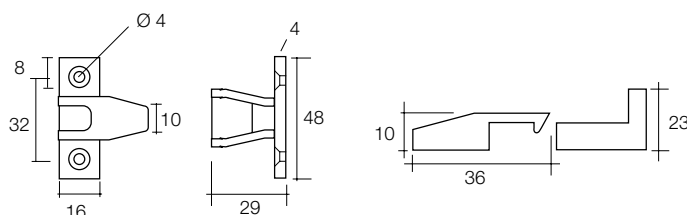
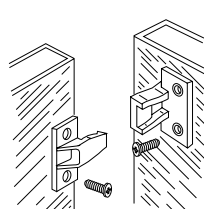

Code	min. order (nr)	qty/box (nr)
750	1000	1000

**751**

Giunto ad infilare in makrolon nero o bianco, in due pezzi, con 4 fori svasati, per assemblaggio laterale dei rivestimenti in legno. Colore: nero.

Slip-on joint in black or white makrolon, in two pieces, with 4 countersunk hole, for side assembly of wood panelling. Colore: nero.

Joint à enfiler en Makrolon noir ou blanc, en deux pièces, avec 4 orifices évasés, pour assemblage latéral des revêtements en bois. Colore: nero.

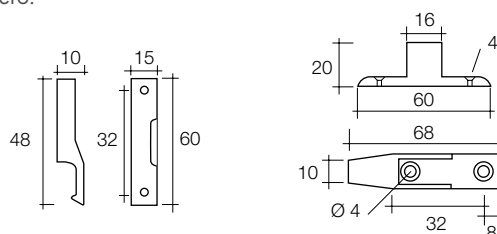
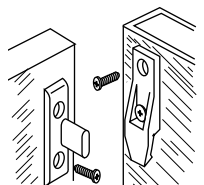

Code	min. order (nr)	qty/box (nr)
751	1000	1000

**GIUNTI**

JOINTS

JOINTS

**752**

Giunto MS + FM ad incastro in nylon con dimensioni ridotte e fori interasse 32 per viti euro. Disponibile anche in kit di montaggio. Colore: grigio.

Nylon M + F click joints with reduced dimensions and hole spacing 32 for Euro-screw. Available also in assembly kits. Colore: grigio.

Joint mâle-femelle à insérer en nylon de dimension réduite et écartement des orifices 32 pour vis euro. Disponible aussi en kit de montage. Colore: grigio.

Code	min. order (nr)	qty./box (nr)
752	500	500

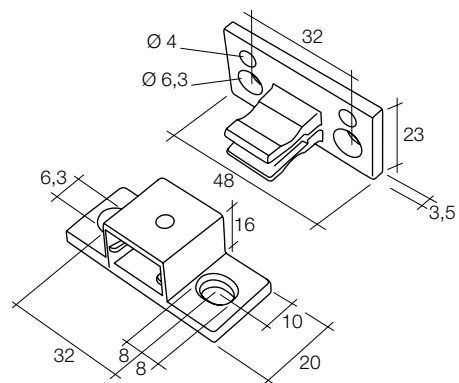

**BUSSOLE**  
BUSGHINGS  
DOUILLES

## BUSSOLE

BUSGHINGS  
DOUILLES

### BUSSOLE AUTOFILETTANTI AD ESPANSIONE

SELF-TAPPING EXPANSION BUSHINGS  
DOUILLES AUTO-TARAUDEUSES À EXPANSION

Code	A	B	C	min. order (nr)	qty./box (nr)
8812	12	3	∅ 5	10000	10000
8815	15	3	∅ 5	10000	10000
8879	7,9	3	∅ 5	10000	10000
8895	9,50	3	∅ 5	10000	10000
8141	12	4	∅ 6	10000	10000

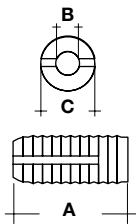

### BUSSOLE AUTOFILETTANTI AD ESPANSIONE CON TESTA

SELF-TAPPING EXPANSION BUSHINGS WITH HEAD  
DOUILLES AUTO-TARAUDEUSES À EXPANSION AVEC TÊTE

Code	A	min. order (nr)	qty./box (nr)
8912	12	10000	10000
8979	7,90	10000	10000
8995	9,50	10000	10000

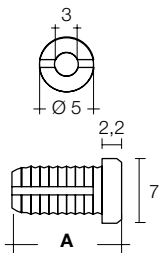

### BUSSOLE AUTOFILETTANTI AD ESPANSIONE - UNITE

COMBINED SELF-TAPPING EXPANSION BUSHINGS  
DOUILLES AUTO-TARAUDEUSES À EXPANSION - UNIES

Code	A	min. order (nr)	qty./box (nr)
9712	12	35000	35000
9795	9,50	50000	50000

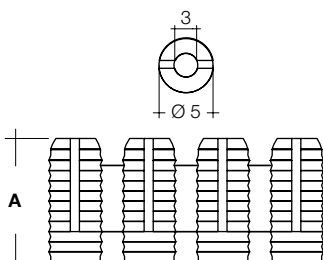

## BUSSOLE

BUSGHINGS  
DOUILLES

### BUSSOLE FILETTATE - Ø 8 - 9

BUSSOLE FILETTATE - Ø 8 - 9  
BUSSOLE FILETTATE - Ø 8 - 9

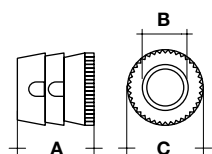

Code	A	B	C	min. order (nr)	qty/box (nr)
8748	8	4 MA	Ø 8	5000	5000
8758	8	5 MA	Ø 8	5000	5000
8441	11	4 MA	Ø 8	5000	5000
8451	11	5 MA	Ø 8	5000	5000
8461	11	6 MA	Ø 8	5000	5000
844T*	11	4 MA	Ø 8	5000	5000
8757	7	5 MA	Ø 9	5000	5000

### BUSSOLE FILETTATE - Ø 11

BUSSOLE FILETTATE - Ø 11  
BUSSOLE FILETTATE - Ø 11

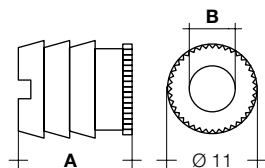

Code	A	B	min. order (nr)	qty/box (nr)
8240	10	4 MA	5000	5000
8241	11	4 MA	5000	5000
8243	13	4 MA	5000	5000
8250	10	5 MA	5000	5000
8269	9	6 MA	5000	5000
8260	10	6 MA	5000	5000
8261	11	6 MA	5000	5000
8263	13	6 MA	5000	5000

### BUSSOLE FILETTATE AD ESPANSIONE

THREADED EXPANSION BUSHINGS  
DOUILLES FILETÉES À EXPANSION

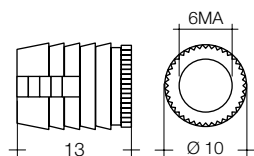

Code	min. order (nr)	qty/box (nr)
7365	5000	5000

### BUSSOLE FILETTATE - UNITE

THREADED BUSHINGS - COMBINED  
DOUILLES FILETÉES - UNIES

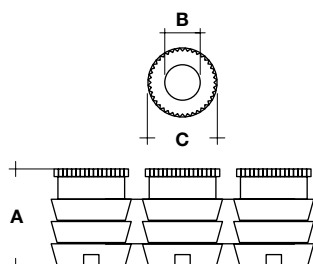

Code	A	B	C	min. order (nr)	qty/box (nr)
8641	11	4 MA	Ø 8	15000	15000
8651	11	5 MA	Ø 8	5000	5000
8661	11	6 MA	Ø 8	5000	5000
8341	11	4 MA	Ø 11	5000	5000
8343	13	4 MA	Ø 11	5000	5000
8351	11	5 MA	Ø 11	5000	5000
8361	11	6 MA	Ø 11	10000	10000
8363	13	6 MA	Ø 11	5000	5000

## BUSSOLE

### BUSGHINGS

### DOUILLES

### BUSSOLE FILETATE AD ESPANSIONE - UNITE

COMBINED THREADED EXPANSION BUSHINGS  
DOUILLES FILETÉES À EXPANSION - UNIES

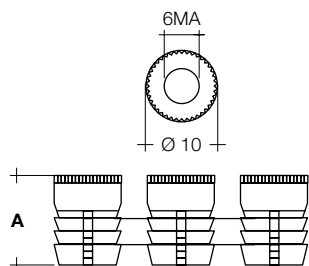

Code	A	min. order (nr)	qty/box (nr)
7362	12	10000	10000
7363	13	5000	5000

### BUSSOLE AUTOFILETTANTI - Ø 8X8

BUSSOLE AUTOFILETTANTI - Ø 8X8  
BUSSOLE AUTOFILETTANTI - Ø 8X8

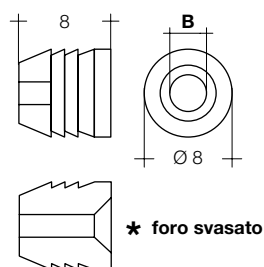

Code	B	min. order (nr)	qty/box (nr)
8729	2,90	5000	5000
8731	3,1 - *sv. 5,5	5000	5000
8732	3,1 - *sv. 6	5000	5000
8738	3,50	5000	5000

### BUSSOLE AUTOFILETTANTI - Ø 8X11

BUSSOLE AUTOFILETTANTI - Ø 8X11  
BUSSOLE AUTOFILETTANTI - Ø 8X11

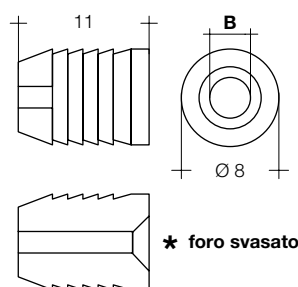

Code	B	min. order (nr)	qty/box (nr)
8421	2,5	5000	5000
8430	2,9	5000	5000
8431	3,5	5000	5000
8432	2,9 - *sv. 5,5	5000	5000
8434	3,1	5000	5000
8435	3,1 - *sv. 6	5000	5000

### BUSSOLE AUTOFILETTANTI - Ø 10,5

BUSSOLE AUTOFILETTANTI - Ø 10,5  
BUSSOLE AUTOFILETTANTI - Ø 10,5

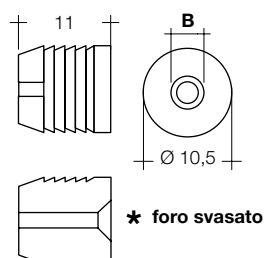

Code	B	min. order (nr)	qty/box (nr)
8229	2,90	5000	5000
8230	3,50	5000	5000
8231	3,5 - *sv. 7	5000	5000
8232	2,9 - *sv. 5,5	5000	5000

## BUSSOLE

### BUSGHINGS

### DOUILLES

## BUSSOLE AUTOFILETTANTI - 12 PEZZI

SELF-TAPPING BUSHINGS - 12 PCS  
DOUILLES AUTO-TARAUDEUSES - 12 PIÈCES

Code	min. order (nr)	qty./box (nr)
8612	5000	5000

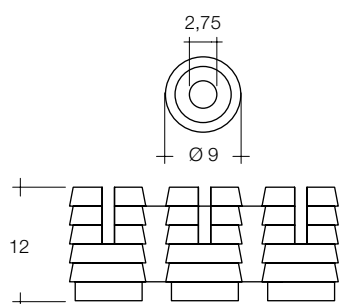

## PO61

Bussola in nylon Ø 8x12xM6 ad espansione con sfera in metallo all'interno. Grande forza di estrazione.

Nylon expansion bushing Ø 8x12xM6 mm with metal ball inside. Large extraction force.

Douille en nylon Ø 8 x 12 x M6 à expansion avec bille en métal à l'intérieur. Grande force d'extraction.

Code	min. order (nr)	qty./box (nr)
PO61	5000	5000

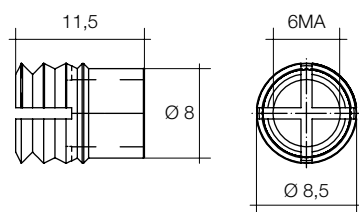

## PS61

Bussola in nylon Ø 8x12xM6 ad espansione senza sfera. Per utilizzo tiranti con punta sferica.

Nylon expansion bushing Ø 8x12xM6 mm without ball. To use with spherical tipped tie rods.

Douille en nylon Ø 8 x 12 x M6 à expansion sans bille. Pour une utilisation de goujons à pointe sphérique.

Code	min. order (nr)	qty./box (nr)
PS61	5000	5000

