

ARTICOLI VARI IN METALLO

VARIOUS METAL ITEMS
ARTICLES DIVERS EN MÉTAL

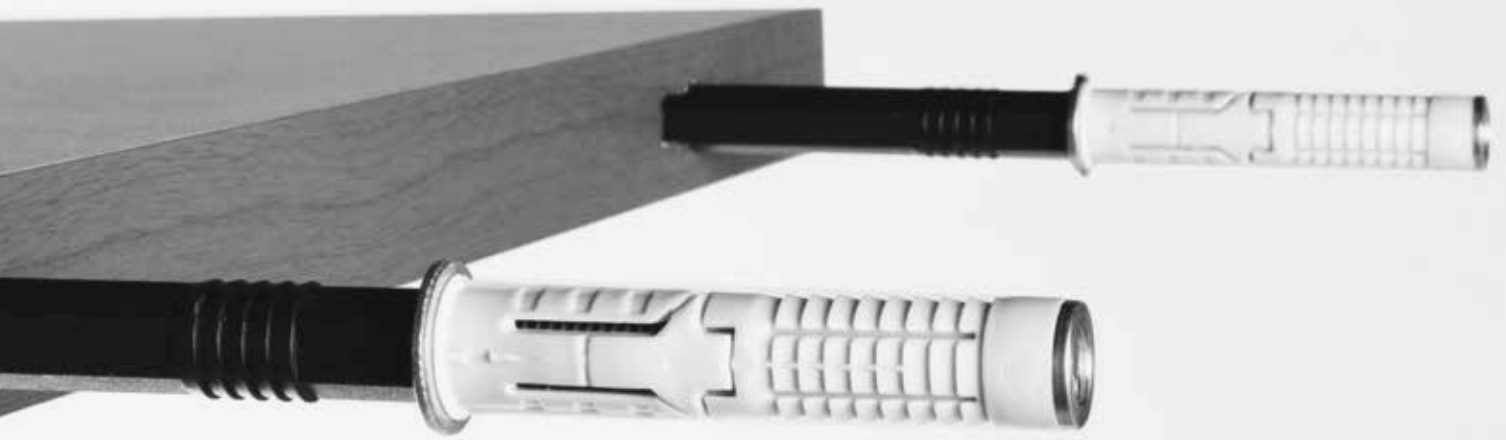

REGGIMENSOLE
SHELF SUPPORTS
SUPPORTS D'ÉTAGÈRE

REGGIMENSOLE

SHELF SUPPORTS
SUPPORTS D'ÉTAGÈRE

270 - 271 - 272 - Ø 9

Reggimensola a scomparsa in metallo, Ø 9 mm, ricoperta in nylon, con tassello Ø 12 mm.

Concealed shelf support in metal, Ø 9 mm, coated in nylon, with dowel Ø 12 mm.

Support d'étagère escamotable en métal, Ø 9 mm, recouvert en nylon, avec écrou Ø 12 mm.

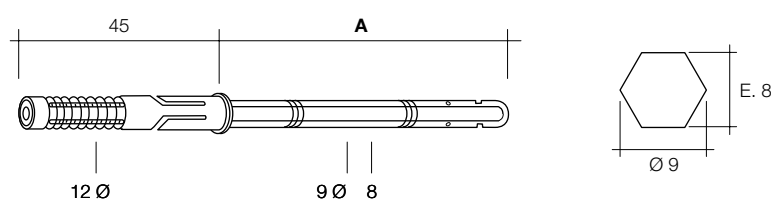

Code	A	min. order (nr)	qty/box (nr)
270/10	80	200	200
271/10	100	200	200
272/10	120	200	200
271/100/12	145	200	200

270 - 271 - Ø 10/12

Reggimensola a scomparsa in metallo, Ø 10-12 mm, ricoperta in nylon, con tassello Ø 12 mm.

Concealed shelf support in metal, Ø 10 - 12 mm, coated in nylon, with dowel Ø 12 mm.

Support d'étagère escamotable en métal, Ø 10 - 12 mm, recouvert en nylon, avec écrou Ø 12 mm.

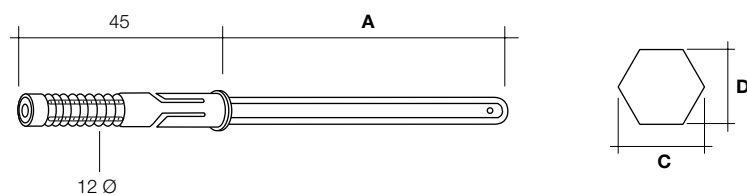

Code	A	C	D	min. order (nr)	qty/box (nr)
270/100/12	100	Ø 10	E 9	200	200
271/12	145	Ø 10	E 9	200	200
270/70/12	70	Ø 12	E 10	200	200
270/120/12	120	Ø 12	E 10	250	250

270 - 271 - 272 - Ø 14

Reggimensola a scomparsa in metallo, Ø 14 mm, ricoperta in nylon, con tassello Ø 14 mm, a doppia espansione.

Concealed shelf support in metal, Ø 14 mm, coated in nylon, with double expansion dowel Ø 14 mm.

Support d'étagère escamotable en métal, Ø 14 mm, recouvert en nylon, avec écrou Ø 14 mm, à double expansion.

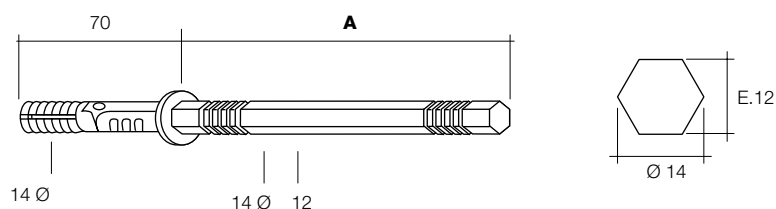

Code	A	min. order (nr)	qty/box (nr)
270/14	120	100	100
271/14	140	100	100
272/14	170	100	100
272/200/14	200	100	100

REGGIMENSOLE

SHELF SUPPORTS

SUPPORTS D'ÉTAGÈRE

270/P - 271/P - 272/P - Ø 14

Reggimensola a scomparsa in metallo, Ø 14 mm, ricoperta in nylon, con tassello a doppia espansione. Assemblata con piastrino in metallo zincato.

Concealed shelf support in metal, Ø 14 mm, coated in nylon, with double expansion. Assembled with galvanized metal plate.

Support d'étagère escamotable en métal, Ø 14 mm, recouvert en nylon, avec écrou à double expansion. Assemblée avec une plaque galvanisée.

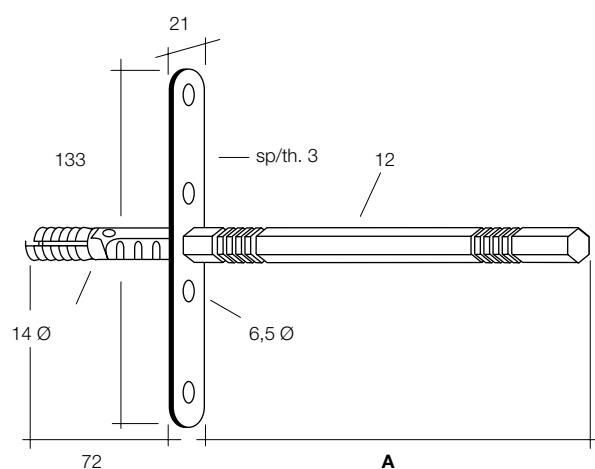

Code	A	min. order (nr)	qty./box (nr)
270/P	120	100	100
271/P	140	100	100
272/P	170	100	100

270/R - 271/R - 272/R - Ø 14

Reggimensola a scomparsa Ø 14x140 mm con boccole eccentriche regolabili.

Concealed Ø14x140mm shelf support with adjustable eccentric bushings.

Support d'étagère escamotable Ø 14x140 mm avec bagues excentriques réglables.

Code	A	min. order (nr)	qty./box (nr)
270/R	120	100	100
271/R	140	100	100
272/R	170	100	100

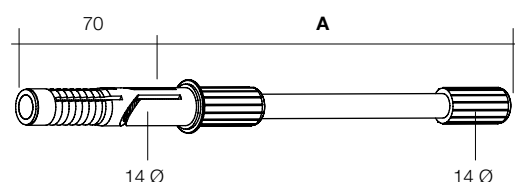

Misure per la foratura
Quotes for the drilling

Profondità foro 150 mm
Hole depth 150 mm

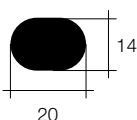

REGGIMENSOLE

SHELF SUPPORTS
SUPPORTS D'ÉTAGÈRE

273

Reggimensola a scomparsa in metallo zincato, Ø 8/10 mm, tassello Ø 10 mm.

Concealed shelf support in galvanized metal, Ø 8/10 mm, dowel Ø 10 mm.

Support d'étagère escamotable, galvanisé, Ø 8/10 mm, écrou Ø 10 mm.

Code	A	B	C	D	min. order (nr)	qty/box (nr)
273/70	70	Ø 8	Ø 8	E 7	200	200
273/1	100	Ø 10	Ø 10	E 8	200	200
273/3	145	Ø 10	Ø 10	E 8	200	200



274

Reggimensola a scomparsa in metallo zincato, Ø 10-12-14 mm, tassello Ø 12-14 mm, a doppia espansione.

Reggimensola a scomparsa in metallo zincato, Ø 10-12-14 mm, tassello Ø 12-14 mm, a doppia espansione.

Support d'étagère escamotable, galvanisé, Ø 10-12-14 mm, écrou Ø 12-14 mm, à double expansion.

Code	A	B	C	D	min. order (nr)	qty/box (nr)
274/1	100	Ø 12	Ø 10	E 8	200	200
274/2	120	Ø 12	Ø 10	E 8	200	200
274/3	145	Ø 12	Ø 10	E 8	180	180
274/3/170	170	Ø 12	Ø 10	E 8	150	150
274/4	100	Ø 14	Ø 12	E 10	150	150
274/5	145	Ø 14	Ø 12	E 10	130	130
274/5/120	120	Ø 14	Ø 12	E 10	150	150
274/9	200	Ø 14	Ø 14	E 12	100	50
274/5/170	170	Ø 14	Ø 12	E 10	120	120
274/6	120	Ø 14	Ø 14	E 12	130	130
274/7	145	Ø 14	Ø 14	E 12	100	100
274/8	170	Ø 14	Ø 14	E 12	100	100

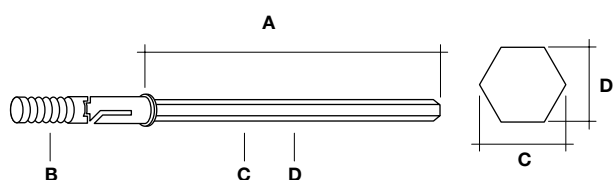

REGGIMENSOLE

SHELF SUPPORTS

SUPPORTS D'ÉTAGÈRE

856

Reggimensola regolabile in zama, imballata singolarmente con viti e tasselli. Finiture disponibili: cromata verniciata alluminio.

Reggimensola regolabile in zama, imballata singolarmente con viti e tasselli. Finiture disponibili: cromata verniciata alluminio.

Reggimensola regolabile in zama, imballata singolarmente con viti e tasselli. Finiture disponibili: cromata verniciata alluminio.

Code	A	B	C	D	qty/box (nr)
856/55	20	55	29	48	100
856/75	29	75	31	55	100
856/105	40	105	40	73	50

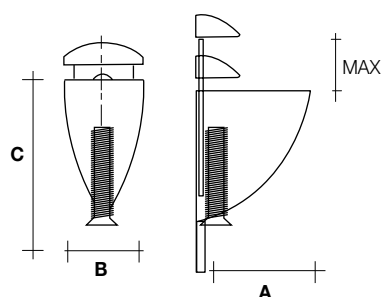
**861**

Nuova reggimensola in zama, regolabile da 5 mm a 25 mm, imballata a coppie con viti e tasselli. Finiture disponibili: cromo lucido e verniciata RAL 9006.

New 50 mm cube shelf support in zamak, adjustable from 4 mm to 20 mm, packed in pairs with screws and dowels. Available finishes: polished chrome and varnished RAL 9006.

Nouveau support d'étagère en Zamak, réglable de 5 mm à 25 mm, emballé par deux, avec vis et écrous. Finitions disponibles: chrome poli et laquée RAL 9006.

Code	min. order (nr)	qty/box (nr)
861	100	100

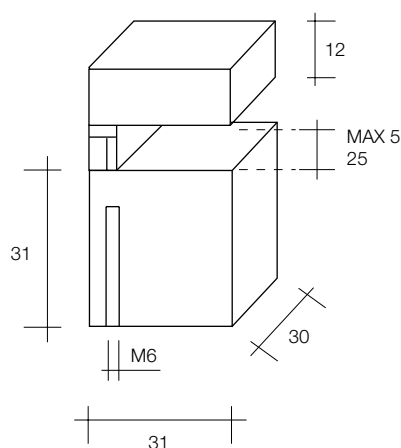

REGGIMENSOLE

SHELF SUPPORTS
SUPPORTS D'ÉTAGÈRE

858

Reggimensola regolabile in zama, imballata singolarmente con viti e tasselli. Finiture disponibili: cromata verniciata alluminio.

Zamak adjustable shelf support, packed individually with screws and dowels. Available finishes: chrome-plated varnished aluminium.

Support d'étagère réglable en Zamak, emballé individuellement avec vis et écrous. Finitions disponibles: chromée laquée aluminium.

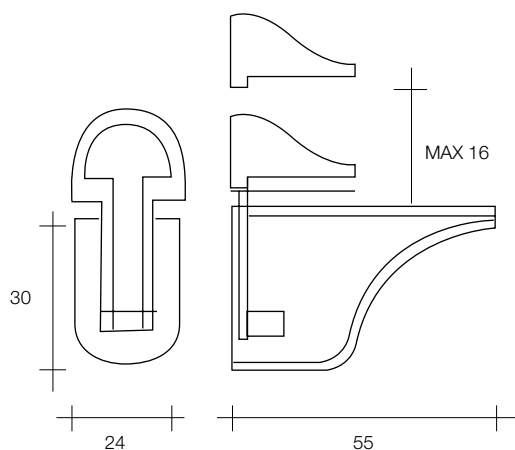

Code	min. order (nr)	qty/box (nr)
858	100	100

862

Nuova reggimensola in zama, regolabile da 4 mm a 20 mm, confezionata a coppie con viti e tasselli. Finiture disponibili: cromo lucido e verniciata RAL 9006.

New 30 mm cube shelf support in zamak, adjustable from 5 mm to 25 mm, packed in pairs with screws and dowels. Available finishes: polished chrome and varnished RAL 9006.

Nouveau support d'étagère en Zamak, réglable de 4 mm à 20 mm, emballé par deux, avec vis et écrous. Finitions disponibles: chrome poli et laquée RAL 9006.

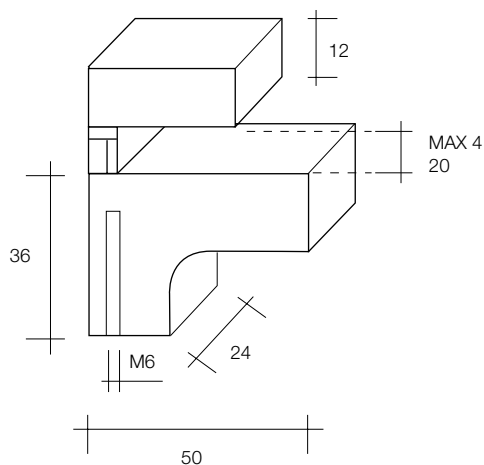

Code	min. order (nr)	qty/box (nr)
862	100	100



PIASTRINI
PLATES
PLAQUES

PIASTRINI

PLATES

PLAQUES

001/Z

Piastrino piano zincato a 6 fori con ceche bombate, 47x70 mm.

6-hole galvanized flat plate with convex housings, 47x70mm.

Plan galvanisé à 6 orifices avec fraises bombées, 47x70 mm.

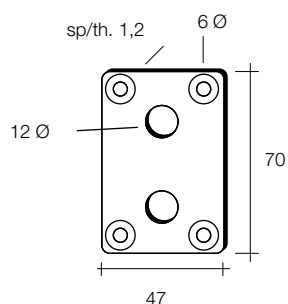

Code	min. order (nr)	qty/box (nr)
001/Z	1000	1000

004/Z

Piastrino piano zincato a 4 fori con ceche bombate, 40x40 mm.

4-hole galvanized flat plate with convex housings, 40x40mm.

Plan galvanisé à 4 orifices avec fraises bombées, 40x40 mm.

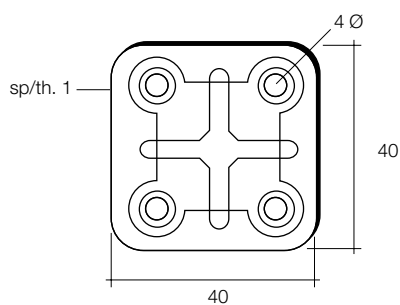

Code	min. order (nr)	qty/box (nr)
004/Z	1000	1000

005/Z

Piastrino piano zincato a 4 con ceche bombate, 45x45 mm.

4-hole galvanized flat plate with convex housings, 45x45mm.

Plan galvanisé à 4 orifices avec fraises bombées, 45x45 mm.

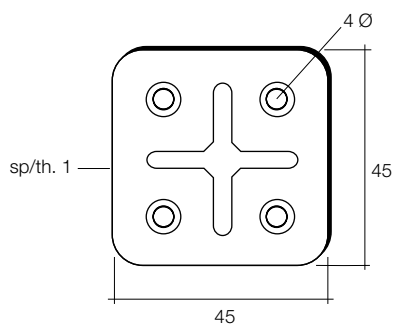

Code	min. order (nr)	qty/box (nr)
005/Z	750	750

PIASTRINI

PLATES

PLAQUES

009/Z-010/Z-011/Z-012/Z

Piastrino zincato a 4 fori.

4-hole, galvanized plate.

Plaque galvanisée à 4 orifices.

Code	A	min. order (nr)	qty/box (nr)
009/Z	60	1500	1500
010/Z	80	1500	1500
011/Z	100	500	500
012/Z	80	1500	1500

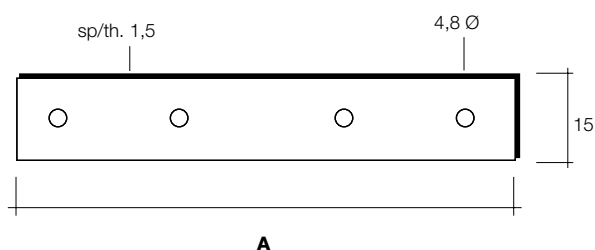

019/Z

Piastrino in metallo zincato con un foro per bloccaggio ante doppie.

Galvanized metal plate with one hole to block double doors.

Plaque galvanisée avec un orifice pour blocage des doubles portes.

Code	min. order (nr)	qty/box (nr)
019/Z	3000	3000

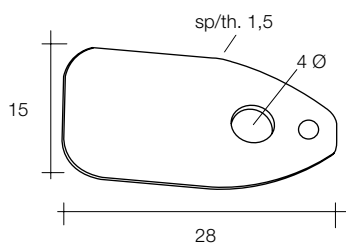

020/Z

Piastrino ad angolo zincato a 4 fori con ceche ed asole, 40x25x25 mm.

4-hole galvanized corner plate with housings and eyelets, 40x25x25 mm.

Plaque angulaire, galvanisée à 4 orifices avec fraises et fentes, 40x25x25 mm.

Code	min. order (nr)	qty/box (nr)
020/Z	1250	1250

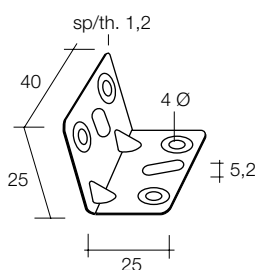

PIASTRINI

PLATES

PLAQUES

021/Z

Piastrino ad angolo zincato a 6 fori, 47x36x36 mm.

6-hole corner plate, 47x36x36 mm galvanized.

Plaque angulaire, galvanisée à 6 orifices, 47x36x26 mm.

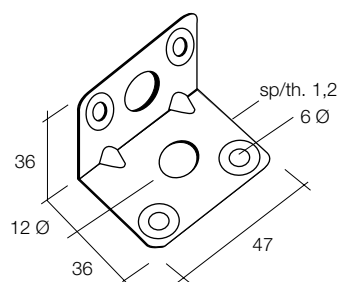

Code	min. order (nr)	qty/box (nr)
021/Z	600	600

027/Z

Piastrino ad angolo zincato a 3 fori, 23x20x27 mm.

3-hole corner plate, 23x20x27 mm galvanized.

Plaque angulaire, galvanisée à 3 orifices, 23x20x27 mm.

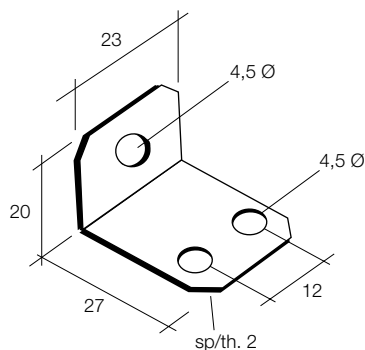

Code	min. order (nr)	qty/box (nr)
027/Z	1250	1250

028/Z, 029/Z, 030/Z

Piastrino ad angolo zincato, rinforzato e nervato, a 4 fori.

4-hole, reinforced and ribbed, galvanized corner plate.

Plaque angulaire, galvanisée, renforcée et nervurée, à 4 orifices.

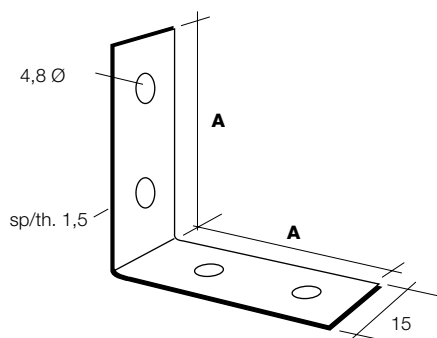

Code	A	min. order (nr)	qty/box (nr)
028/Z	30	2000	2000
029/Z	40	1250	1250
030/Z	50	500	500
043/Z	60	500	500

PIASTRINI

PLATES

PLAQUES

031/Z

Piastrino ad angolo zincato, rinforzato e nervato, con 2 fori e 1 asola e ceche bombate, 15x40x40 mm.

Reinforced and ribbed galvanized corner plate with 4 holes and 1 eyelet and convex housings, 15x40x40 mm.

Plaque angulaire, galvanisée, renforcée et nervurée, avec 2 orifices, 1 fente et des fraises bombées, 15x40x40 mm.

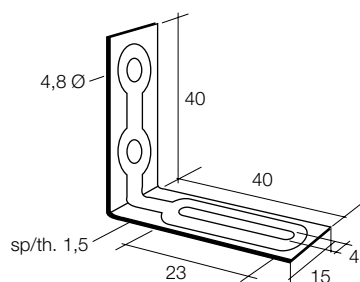

Code	min. order (nr)	qty/box (nr)
031/Z	1500	1500

032/Z

Piastrino ad angolo zincato a 2 fori.

Piastrino ad angolo zincato a 2 fori.

Piastrino ad angolo zincato a 2 fori.

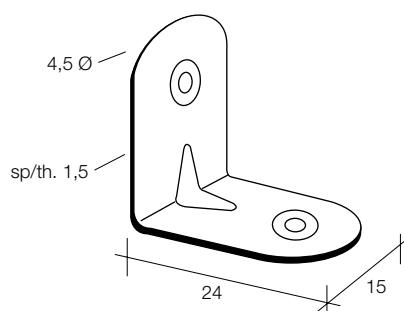

Code	A	min. order (nr)	qty/box (nr)
032/Z	24	2000	2000
032/Z/17	17	3000	3000

036/Z

Piastrino ad angolo zincato a 2 asole, 15x32x77 mm.

Piastrino ad angolo zincato a 2 asole, 15x32x77 mm.

Piastrino ad angolo zincato a 2 asole, 15x32x77 mm.

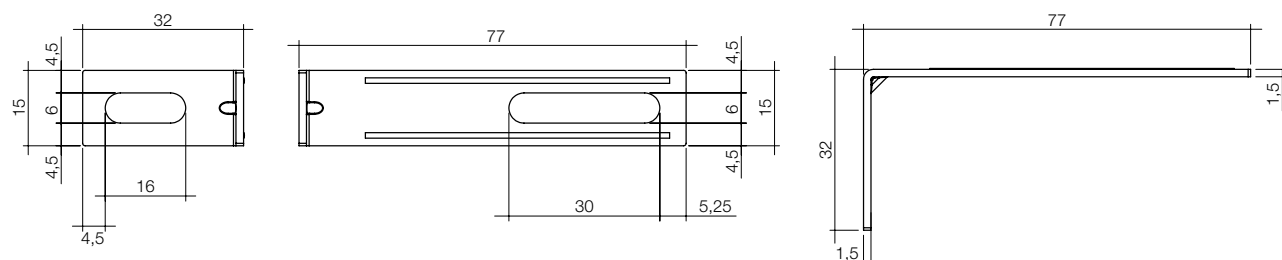

Code	min. order (nr)	qty/box (nr)
036/Z	500	500

PIASTRINI

PLATES

PLAQUES

540/CA

Piastrino in metallo zincato ad angolo (45°) per fissaggio cornici.
Angolo modellabile.

(45°) galvanized metal corner plate to fix frames. Mouldable corner.

Plaque galvanisée à angle (45°) pour fixation des cadres.
Angle modulable.

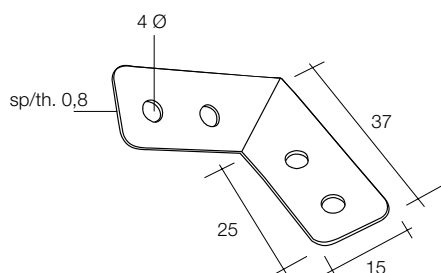

Code	min. order (nr)	qty/box (nr)
540/CA	1000	1000

540/LU/C

Piastrino in metallo zincato per il sostegno della base cassetto e per il bloccaggio fronte-base con possibilità di regolazione del fronte. Fori interasse 32 mm per Eurovite.

Galvanized metal plate for the support of the drawer base and for front-base locking with the possibility of adjusting the front. Hole spacing 32 mm for Euro-screw

Plaque galvanisée pour le soutien de la base tiroir et pour le blocage devant-base avec possibilité de réglage du devant. Écartement des orifices 32 mm pour vis euro.

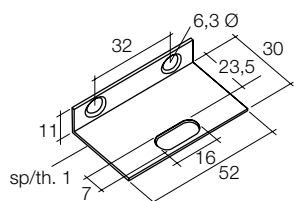

Code	min. order (nr)	qty/box (nr)
540/LU/C	1250	1250

Eurovite testa svasata piana: - Sez. 8 pag. 3 art. 400
Flat countersunk head Euro screw: - Sect. 8 page 3 art. 400
Vis euro tête évasée plate: - Section 8 page 3 art. 400

**540/LU/P**

Perno in metallo zincato Ø 6 mm per bloccaggio Art. 540/LU/C e Art. 540/I/C.

Ø 6 mm galvanized metal pin of block Art. 540/LU/C and Art. 540/I/C.

Goujon en galvanisé Ø 6 mm pour blocage Art. 540/LU/C et Art. 540/I/C.

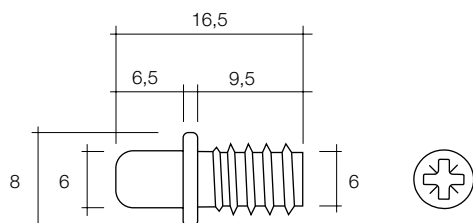

Code	min. order (nr)	qty/box (nr)
540/LU/P	1250	1250

PIASTRINI

PLATES
PLAQUES

540/I/C

Piastrino per il bloccaggio base-fronte cassetto. Regolazione orizzontale e verticale fronte-base.

Plate for drawer base-front locking. Horizontal and vertical front-base adjustment.

Plaque pour la blocage base-devant du tiroir. Réglage horizontal et vertical devant-base.

Code	min. order (nr)	qty/box (nr)
540/I/C	1000	1000

Eurovite testa svasata piana: - Sez. 8 pag. 3 art. 400
Flat countersunk head Euro screw: - Sect. 8 page 3 art. 400
Vis euro tête évasée plate: - Section 8 page 3 art. 400

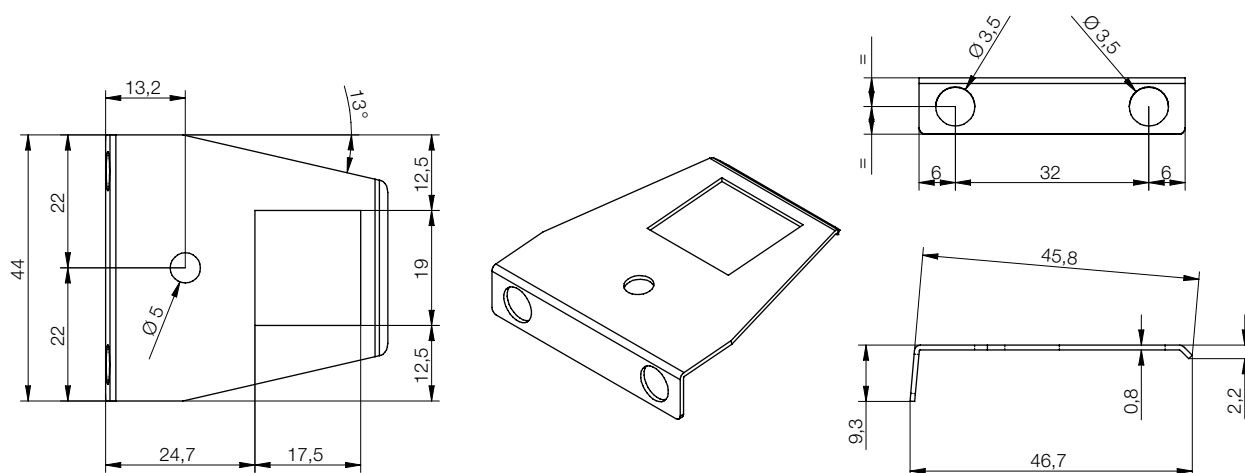

540/I/R

Riscontro per piastrino Art. 540/I/C.

Striker for plate Art. 540/I/C.

Juxtaposition pour plaque Art. 540/I/C.

Code	min. order (nr)	qty/box (nr)
540/I/R	1000	1000

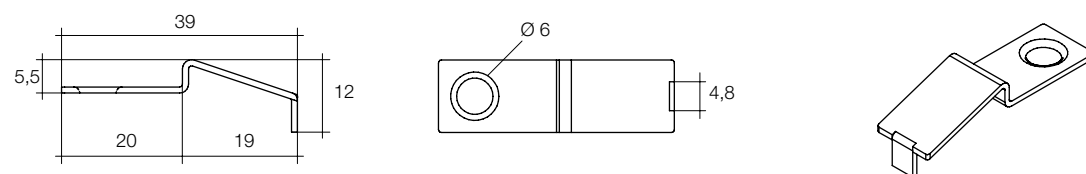

STEP -1



STEP -2



STEP -3



**MORSETTI
FERMA TOP**
FASTENING BRACKETS
FOR TOPS
DISPOSITIF DE BLOCAGE
DU PLAN DE TRAVAIL

MORSETTI FERMA TOP

FASTENING BRACKETS FOR TOPS

DISPOSITIF DE BLOCAGE DU PLAN DE TRAVAIL

329/10

Chiave E10 in metallo zincato per morsetto Art. 330.

Spoon-shaped E.13 key, in galvanized metal

Clé E.13 en galvanisé, ondulée.

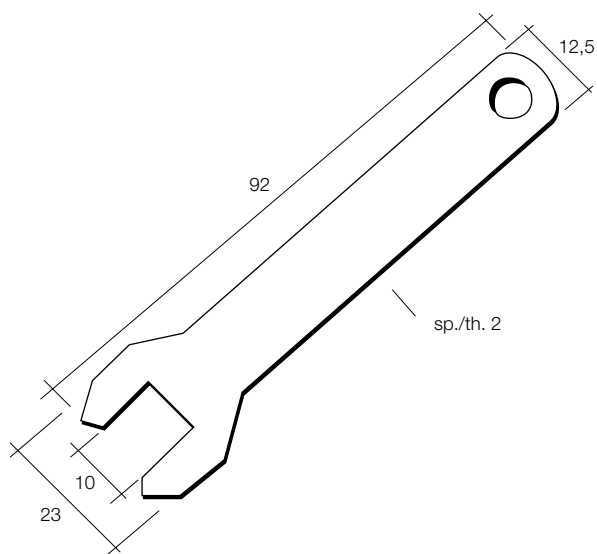

Code	min. order (nr)	qty/box (nr)
329/10	1500	1500

330

Morsetto tirante in metallo zincato, per fissaggio top, completo di mezzelune e dado E.10.

Galvanized metal pulling clamp for fixing tops complete with the half-moon shaped plates and E.10 nut.

Etau tirant en metal zingué, pour fixation tops, complet de croissants et écrou E.10

Code	A	min. order (nr)	qty/box (nr)
330/065	65	500	500
330/085	85	500	500
330/100	100	500	500
330/120	120	500	500
330/150	150	500	500
330/190	190	500	500

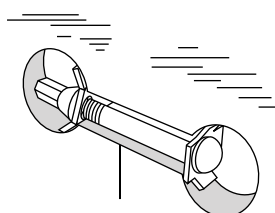
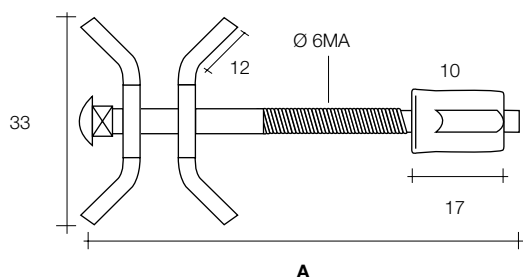



**VITERIA E
GIUNZIONI**
SCREWS AND JOINTS
VIS ET JONCTIONS

VITERIA E GIUNZIONI

SCREWS AND JOINTS

VIS ET JONCTIONS

174

Vite di giunzione Ø 5 mm in metallo. (Misure come da schema).
Finiture disponibili: nichelata.

Joining screw Ø 5 mm in metal. (Measurements as per diagram)
Available finishes: nickel-plated.

Vis de jonction, Ø 5 mm, en métal. (Mesures selon le tableau).
Finitions disponibles: nickelée.

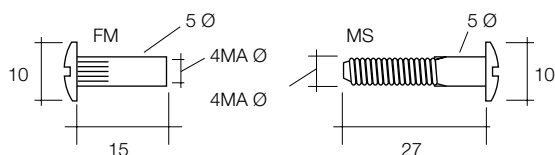

Code	min. order (nr)	qty/box (nr)
174/MS	20000	5000
174/FM	20000	20000

175

Vite di giunzione Ø 5 in metallo. (Misure come da schema).
Finiture disponibili: nichelata.

Joining screw Ø 5 mm in metal. (Measurements as per diagram)
Available finishes: nickel-plated.

Vis de jonction, Ø 5 mm, en métal. (Mesures selon le tableau).
Finitions disponibles: nickelée.

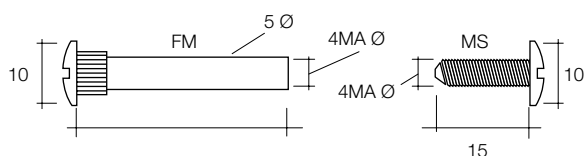

Code	min. order (nr)	qty/box (nr)
175/MS	10000	10000
175/FM	10000	5000

**176**

Nuova vite di giunzione Ø 5 mm in metallo con testa di spessore ridotto. Finitura: nichelata - brunita.

New fastening screw Ø 5 mm in metal with reduced thickness head. Finish: nickel-plated - burnished.

Nouvelle vis de jonction Ø 5 mm en métal avec tête d'épaisseur réduite. Finition: nickelée - brunie.

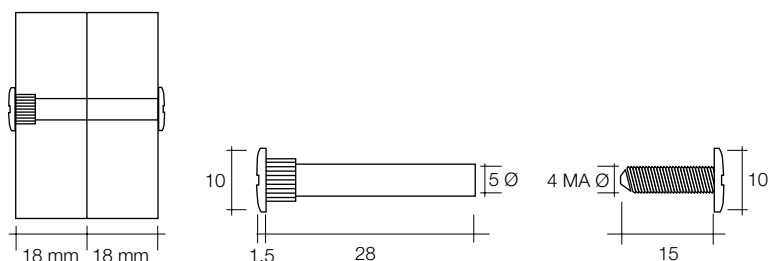

Code	min. order (nr)	qty/box (nr)
176/MS	10000	5000
176/FM	10000	10000



VITERIA E GIUNZIONI

SCREWS AND JOINTS

VIS ET JONCTIONS

177

Vite di giunzione Ø 8 mm in metallo. (Misure come da schema).
Finiture disponibili: nichelata.

Joining screw Ø 8 mm in metal. (Measurements as per diagram) Available finishes: nickel-plated.

Vis de jonction, Ø 8 mm, en métal. (Mesures selon le tableau). Finitions disponibles: nickelée.

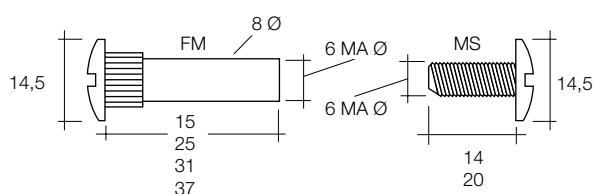

Code	min. order (nr)	qty./box (nr)
177/MS	2000	2000
177FM	2000	2000

177/S

Vite di giunzione Ø 8 mm in metallo. (Misure come da schema).
Finiture disponibili: nichelata.

Joining screw Ø 8 mm in metal. (Measurements as per diagram) Available finishes: nickel-plated.

Vis de jonction, Ø 8 mm, en métal. (Mesures selon le tableau). Finitions disponibles: nickelée.

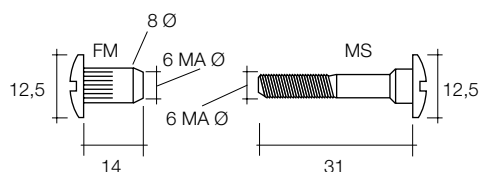

Code	min. order (nr)	qty./box (nr)
177/S/MS	6000	1500
177/S/FM	6000	2000

400

Vite EURO TSP e TB Ø 6,3 mm. Finiture: zincata - nichelata.

EURO TSP and TB screw Ø 6,3 mm Finishes: galvanized - nickel-plated.

Vis euro TSP et TB, Ø 6,3 mm. Finitions: galvanisée - nickelée.

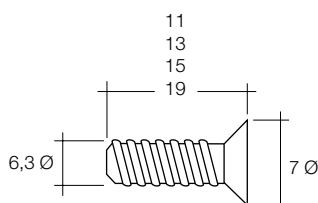

Code	min. order (nr)	qty./box (nr)
400	10000	10000

VITERIA E GIUNZIONI

SCREWS AND JOINTS

VIS ET JONCTIONS

401

Vite zappetta zincata. (Misure come da schema). Disponibile anche con tasselli.

Galvanized hook screw. (Measurements as per diagram). Available also with dowels.

Vis en forme de sarcloir, zinguée. (Mesures selon le tableau). Disponible aussi avec chevilles.

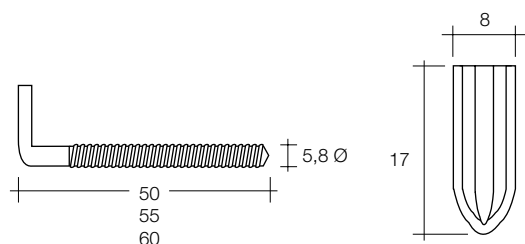

Code	min. order (nr)	qty./box (nr)
401	10000	1000

403

Vite di montaggio, zincata, punta tronca, TE, sottotesta liscia.

Mounting screw, galvanized, round tip, TE, smooth underhead.

Vis de montage, galvanisée, pointe tronquée, TE, sous tête lisse.

Code	A	min. order (nr)	qty./box (nr)
403	50	2000	2000
403	50/60	2000	2000

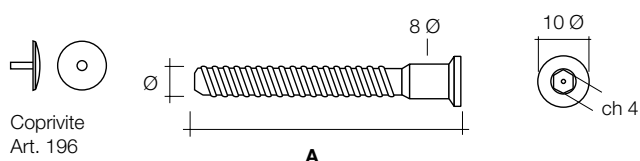

Coprivite
Art. 196

403/1

Vite di montaggio, zincata, punta tronca, PZD, sottotesta zigrinata.

Mounting screw, galvanized, round tip, PZD, knurled underhead.

Vis de montage, galvanisée, pointe tronquée, PZD, sous tête moleté.

Code	min. order (nr)	qty./box (nr)
403/1	2000	2000

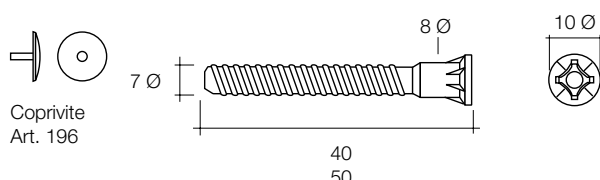

Coprivite
Art. 196

VITERIA E GIUNZIONI

SCREWS AND JOINTS

VIS ET JONCTIONS

VITI 176/MS

Vite 4MA per maniglie con testa piatta, zincata.

Galvanized 4MA screw for flat head handles.

Vis 4MA pour poignées avec tête plate, galvanisée.

Code	A	min. order (nr)	qty./box (nr)
176MS1	15	10000	10000
176MS2	19	10000	10000
176MS3	25	7800	7800
176MS4	27	7000	7000
176MS5	29	6800	6800

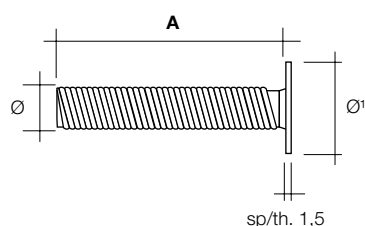

378

Regolabile zincato con testa esagonale, vite 6MA 25, completo di bussola zincata e coprivite Art. 396.

Adjustable, galvanized with hexagonal head, screw 6MA 25, complete with galvanized bushing and screw cap Art. 396.

Système réglable galvanisé avec tête hexagonale, vis 6MA 25, complété par douille zinguée et cache-vis Art. 396.

Code	min. order (nr)	qty./box (nr)
378	1500	1500

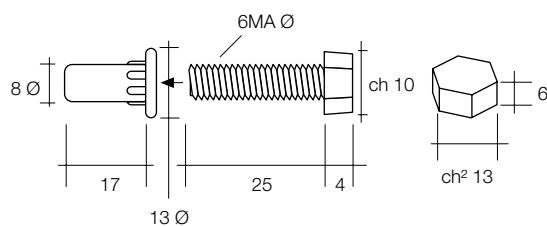

565

Eccentrico in zama Ø 15 mm. Finitura: zama grezzo - zincato - tropicalizzato - zincato nero - nichelato - bronzato - ottonato.

Ø 15 mm zamak eccentric. Finish: untreated - galvanized - tropicalized - black galvanized - nickel-plated - bronzed - brass-plated zamak

Excentrique en Zamak Ø 15 mm. Finition: Zamak naturel - galvanisé - tropicalisé - galvanisé noir - nickelé - bronzé - laitonné.

Code	A	B	C	min. order (nr)	qty./box (nr)
565	10	6	12	2000	2000
565	12	7,5	15	2000	2000
565	12,5	8	16	2000	2000
565	13,8	9/9,5	18/20	2000	2000
565	17	12,5	25	2000	2000
565	19	14,5	28/30	1250	1250

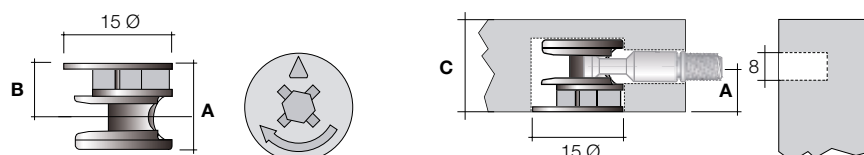

VITERIA E GIUNZIONI

SCREWS AND JOINTS

VIS ET JONCTIONS

565/15

Eccentrico Power in zama Ø 15 mm. Finitura: zama grezzo - zincato - tropicalizzato - zincato nero - nichelato - bronzato - ottonato.

Ø 15 mm zamak Eccentric Power. Finish: untreated - galvanized - tropicalized - black galvanized - nickel-plated - bronzed - brass-plated zamak

Excentrique Power en Zamak Ø 15 mm. Finition: Zamak naturel - galvanisé - tropicalisé - galvanisé noir - nickelé - bronzé - laitonné.

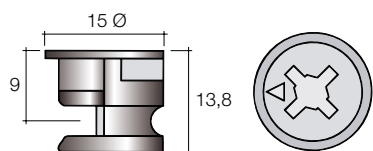

Code	min. order (nr)	qty/box (nr)
565/15	2000	2000

565/CB

Eccentrico in zama Ø 15 mm con bordo. Finitura: zama grezzo - zincato - tropicalizzato - zincato nero - nichelato - bronzato - ottonato.

Ø 15 mm zamak eccentric with edge. Finish: untreated - galvanized - tropicalized - black galvanized - nickel-plated - bronzed - brass-plated zamak

Excentrique en Zamak Ø 15 mm avec bord. Finition: Zamak naturel - galvanisé - tropicalisé - galvanisé noir - nickelé - bronzé - laitonné.

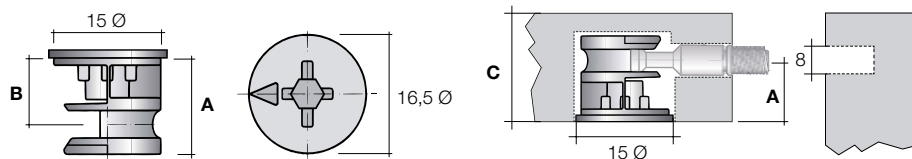

Code	A	B	C	min. order (nr)	qty/box (nr)
565/CB	13,8	9/9,5	18/20	2000	2000
565/CB	17	12,5	25	2000	2000
565/CB	19	14,5	28/30	2000	2000

565/15/CB

Eccentrico Power in zama Ø 15 mm con bordo. Finitura: zama grezzo - zincato - tropicalizzato - zincato nero - nichelato - bronzato - ottonato.

Ø 15 mm zamak Eccentric Power with edge. Finish: untreated - galvanized - tropicalized - black galvanized - nickel-plated - bronzed - brass-plated zamak

Excentrique Power en Zamak Ø 15 mm avec bord. Finition: Zamak naturel - galvanisé - tropicalisé - galvanisé noir - nickelé - bronzé - laitonné.

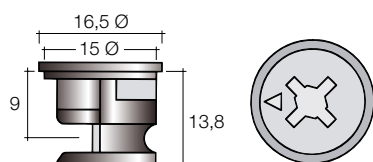

Code	min. order (nr)	qty/box (nr)
565/15/CB	2000	2000

VITERIA E GIUNZIONI

SCREWS AND JOINTS

VIS ET JONCTIONS

567

Tirante in ferro per eccentrico. Finitura: zincato.

Iron tie rod for eccentric. Finish: galvanized.

Goujon en fer pour excentrique. Finition: galvanisé.

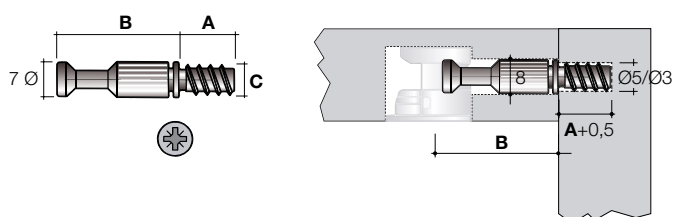

Code	A	B	C	min. order (nr)	qty/box (nr)
567	11	34	6 EURO	2000	2000
567	12,5	34	4 EURO	2000	2000
567	7,5	34	6 EURO	1250	1250
567	15	34	6 EURO	2500	2500
567	11	24	6 EURO	2500	2500
567	11	28	6 EURO	2000	2000
567	12,5	24	4 EURO	3000	3000

566

Tirante in ferro per eccentrico. Finitura: zincato.

Iron tie rod for eccentric. Finish: galvanized.

Goujon en fer pour excentrique. Finition: galvanisé.

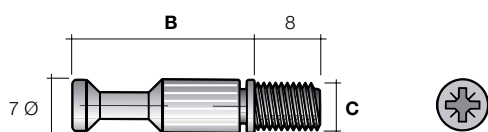

Code	B	C	min. order (nr)	qty/box (nr)
566	34	M6	2000	2000
566	24	M6	2500	2500
566	34	M4	2000	2000
566	24	M4	3000	3000
566	28	M6	2500	2500

566/R

Tirante in ferro rullato. Finitura: zincato.

Rolled iron tie rod. Finish: galvanized.

Goujon en fer cannelé. Finition: galvanisé.

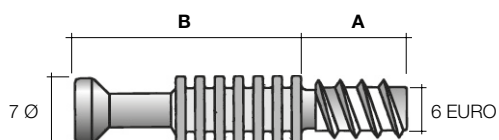

Code	A	B	min. order (nr)	qty/box (nr)
566/R	11	34	2000	2000
566/R	11	24	2500	2500
566/R	8,6	34	2000	2000

VITERIA E GIUNZIONI

SCREWS AND JOINTS

VIS ET JONCTIONS

568/8

Tirante ad espansione in ferro e plastica Ø 8 mm. Finitura: zincato.

Expansion tie rod in iron and plastic Ø 8 mm. Finish: galvanized.

Goujon à expansion en fer et plastique, Ø 8 mm. Finition: galvanisé.

Code	B	min. order (nr)	qty/box (nr)
568/8	24	2000	2000
568/8	34	2000	2000
568/8	28	2000	2000
568/8	21,5	2000	2000

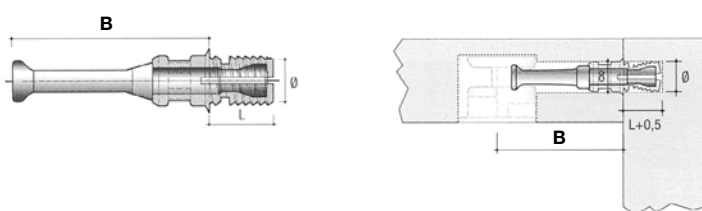
**568/10**

Tirante ad espansione in ferro e plastica Ø 10 mm. Finitura: zincato.

Expansion tie rod in iron and plastic Ø 10 mm. Finish: galvanized.

Goujon à expansion en fer et plastique, Ø 10 mm. Finition: galvanisé.

Code	B	min. order (nr)	qty/box (nr)
568/10	24	2000	2000
568/10	34	2000	2000

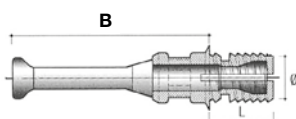
**564**

Eccentrico in zama Ø 12 mm. Finitura: zama grezzo - zincato - tropicalizzato - zincato nero - nichelato.

Ø 12 mm zamak eccentric. Finish: untreated - galvanized - tropicalized - black galvanized - nickel-plated zamak

Excentrique en Zamak Ø 12 mm. Finition: Zamak naturel - galvanisé - tropicalisé - galvanisé noir - nickelé.

Code	min. order (nr)	qty/box (nr)
564	5000	5000

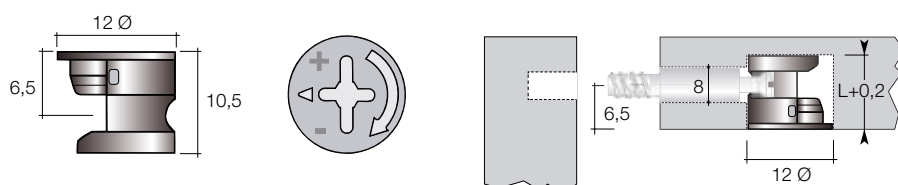

VITERIA E GIUNZIONI

SCREWS AND JOINTS

VIS ET JONCTIONS

564/CB

Eccentrico in zama Ø 12 mm con bordo. Finitura: zama grezzo - zincato - nichelato - zincato nero.

Ø 12 mm zamak eccentric with edge. Finish: untreated - galvanized - nickel plated - black galvanized zamak

Excentrique en Zamak Ø 12 mm avec bord. Finition: Zamak naturel - galvanisé - nickelé - galvanisé noir.

Code	min. order (nr)	qty/box (nr)
564/CB	5000	5000

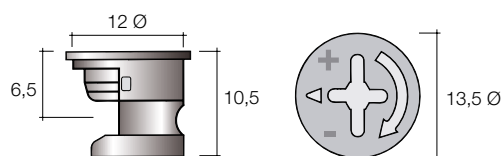
**564/R**

Tirante in ferro rullato. Finitura: zincato.

Rolled iron tie rod. Finish: galvanized.

Goujon en fer cannelé. Finition: galvanisé.

Code	min. order (nr)	qty/box (nr)
564/R	2000	2000

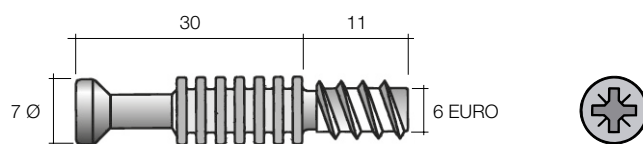
**460**

Barilotto in ferro Ø 10 mm. Finitura: zincato - zincato nero - tropicalizzato.

Iron barrel Ø 10 mm. Finish: galvanized - galvanized black - tropicalized.

Barillet en fer Ø 10 mm. Finition: galvanisé - galvanisé noir - tropicalisé.

Code	A	B	C	min. order (nr)	qty/box (nr)
460	13	8	16	2500	2500
460	14	9	18	2500	2500
460	16	11	22	2500	2500
460	17,50	12,50	25	2500	2500
460	19	14	28/30	2500	2500
460	12	7	14	2500	2500

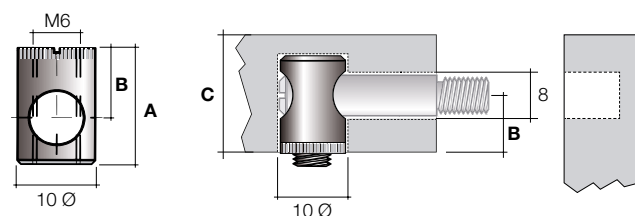

VITERIA E GIUNZIONI

SCREWS AND JOINTS

VIS ET JONCTIONS

470

Grano in ferro M6. Finitura: zincato - zincato nero - tropicalizzato.

M6 iron grub screw. Finish: galvanized - galvanized black - tropicalized.

Vis pointeau en fer M6. Finition: galvanisé - galvanisé noir - tropicalisé.

Code	A	min. order (nr)	qty/box (nr)
470/M6	8	10000	10000
470/M6	9	10000	10000
470/M6	12	10000	10000
470/M6	14	10000	10000
470/M6	8	10000	10000

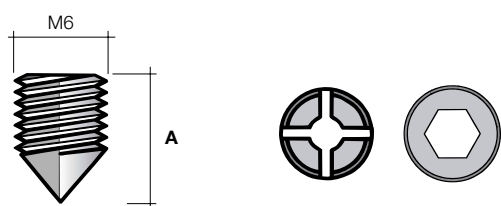
**460/CB**

Barilotto Ø 14 mm con bordo in zama. Finitura: zincato - tropicalizzato - zincato nero - bronzato.

Ø 14 mm housing with zamak edge. Finish: galvanized - tropicalized - galvanized black - bronzed.

Barillet Ø 14 mm avec bord en Zamak. Finition: galvanisé - tropicalisé - zingué noir - bronzé.

Code	A	B	C	min. order (nr)	qty/box (nr)
460/CB	13	8	16	2000	2000
460/CB	14	9	18	2000	2000
460/CB	15	10	20	2000	2000
460/CB	16	11	22	2000	2000
460/CB	17,50	12,50	25	1250	1250

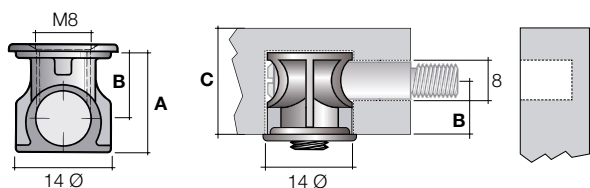
**460/SB**

Barilotto in zama Ø 14 mm e Ø 15 mm senza bordo. Finitura: zincato - tropicalizzato - zincato nero - bronzato.

Ø 14mm and Ø 15mm zamak housing, no edge. Finish: galvanized - tropicalized - galvanized black - bronzed.

Barillet en Zamak Ø 14 mm et Ø 15 mm sans bord. Finition: galvanisé - tropicalisé - zingué noir - bronzé.

Code	A	B	C	D	min. order (nr)	qty/box (nr)
460/SB	13	8	Ø 14	16	2000	2000
460/SB	14	9	Ø 14	18	2000	2000
460/SB	15	10	Ø 14	20	2000	2000
460/SB	16	11	Ø 14	22	2000	2000
460/SB	17,50	12,50	Ø 14	25	1250	1250
460/SB	13	8	Ø 15	16	2000	2000
460/SB	14	9	Ø 15	18	2000	2000
460/SB	15	10	Ø 15	20	2000	2000

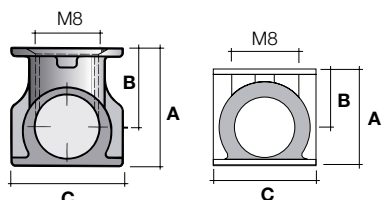

VITERIA E GIUNZIONI

SCREWS AND JOINTS

VIS ET JONCTIONS

470/M8

Grano in ferro o zama M8. Finitura: zama grezzo - zincato - tropicalizzato - zincato nero - bronzato.

M8 zamak or iron grub screw. Finish: untreated - galvanized - tropicalized - black galvanized - bronzed zamak

Vis pointeau en fer ou en Zamak M8. Finition: Zamak naturel - galvanisé - tropicalisé - galvanisé noir - bronzé.

Code	A	D	min. order (nr)	qty./box (nr)
470/M8	8	Zama	10000	10000
470/M8	10	Zama	10000	10000
470/M8	10	Ferro	5000	5000
470/M8	12	Zama	5000	5000
470/M8	12,50	Ferro	5000	5000

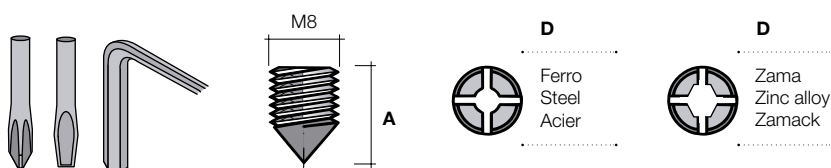

480

Tirante in ferro Ø 7 mm. Finitura: zincato.

Iron tie rod Ø 7 mm. Finish: galvanized.

Goujon en fer, Ø 7 mm. Finition: galvanisé.

Code	A	B	C	D	min. order (nr)	qty./box (nr)
480	33,50	18,50	Ø 7	M6	2000	2000
480	35	20	Ø 7	M6	2000	2000
480	43,50	28,50	Ø 7	M6	2000	2000
480	45	30	Ø 7	M6	2000	2000
480	65	49	Ø 7	M6	2000	2000
480	36	20	Ø 8	M8	2000	2000
480	37	20	Ø 7	6 EURO	2000	2000
480	45	27	Ø 7	6 EURO	2000	2000

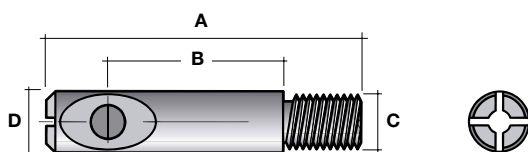

461

Nuovo barilotto in ferro Ø 14 mm con foro laterale. Finitura: zincato - zincato nero.

New Ø 14 mm iron housing with side hole. Finish: galvanized - black galvanized.

Nouveau barillet en fer Ø 14 mm avec orifice latéral. Finition: galvanisé - galvanisé noir.

Code	min. order (nr)	qty./box (nr)
461	2500	2500

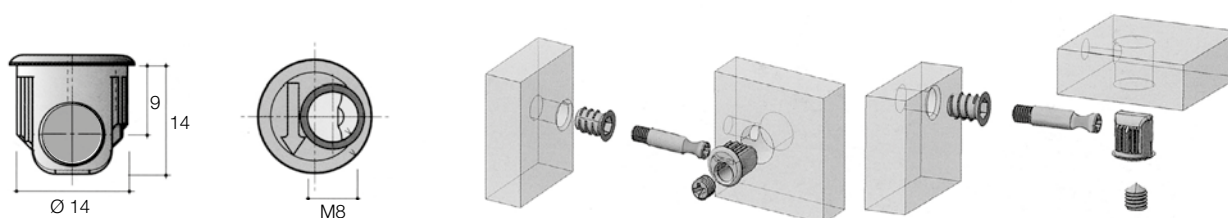

VITERIA E GIUNZIONI

SCREWS AND JOINTS

VIS ET JONCTIONS

481

Nuovo tirante in ferro Ø 7 mm. Finitura: zincato.

New Ø 7 mm iron tie rod. Finish: galvanized.

Nouveau goujon en fer Ø 7 mm. Finition: galvanisé.

Code	min. order (nr)	qty/box (nr)
481	2000	2000

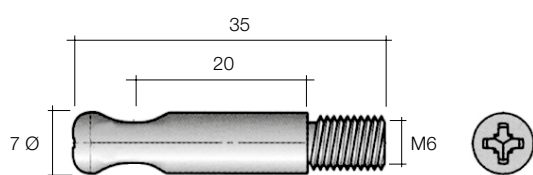
**471**

Nuovo grano in ferro M8. Finitura: zincato - zincato nero.

New M8 iron grub screw. Finish: galvanized - black galvanized. Finish: galvanized - black galvanized.

Nouvelle vis pointeau en fer M8. Finition: galvanisé - galvanisé noir.

Code	min. order (nr)	qty/box (nr)
471	8000	8000

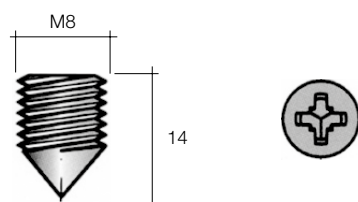
**460/CB**

Barilotto in zama Ø 16 mm con bordo. Finitura: zama grezzo - zincato - tropicalizzato - zincato nero - bronzato.

Ø 16 mm zamak housing with edge. Finish: untreated - galvanized - tropicalized - black galvanized - bronzed zamak

Barillet en Zamak Ø 16 mm avec bord. Finition: Zamak naturel - galvanisé - tropicalisé - galvanisé noir - bronzé.

Code	A	B	C	min. order (nr)	qty/box (nr)
460/CB	18	11	22	1000	1000
460/CB	19,50	12,50	25	1000	1000
460/CB	22	15	30	1000	1000

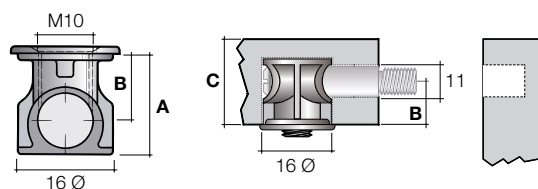

VITERIA E GIUNZIONI

SCREWS AND JOINTS

VIS ET JONCTIONS

460/SB

Barilotto in zama Ø 16 mm senza bordo. Finitura: zincato - tropicalizzato - zincato nero - bronzato.

Ø 16 mm zamak housing, no edge. Finish: galvanized - tropicalized - galvanized black - bronzed.

Barillet en Zamak Ø 16 mm sans bord. Finition: galvanisé - tropicalisé - zingué noir - bronzé.

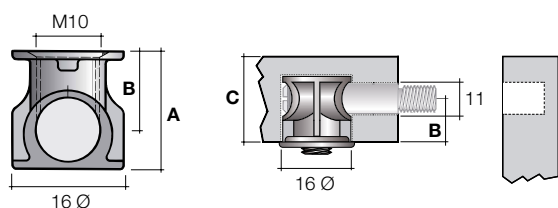

Code	A	B	C	min. order (nr)	qty/box (nr)
460/SB	18	11	22	1000	1000
460/SB	19,50	12,50	25	1000	1000
460/SB	22	15	30	1000	1000

470/M10

Grano in ferro o zama M10. Finitura: zama grezzo - zincato - tropicalizzato - zincato nero - bronzato.

M10 zamak or iron grub screw. Finish: untreated - galvanized - tropicalized - black galvanized - bronzed zamak

Vis pointeau en fer ou en Zamak M10. Finition: Zamak naturel - galvanisé - tropicalisé - galvanisé noir - bronzé.

Code	A	D	min. order (nr)	qty/box (nr)
470/M10	12,50	Zama	5000	5000
470/M10	13,50	Zama	5000	5000
470/M10	16	Zama	5000	5000
470/M10	16	Ferro	2500	2500
470/M10	12,50	Ferro	2500	2500

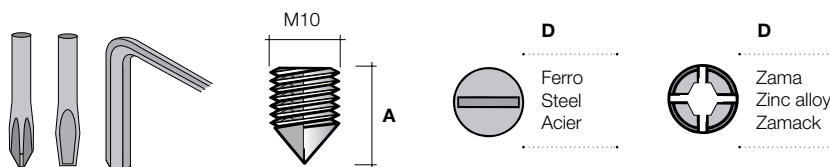
**480/10**

Tirante in ferro Ø 10 mm. Finitura: zincato.

Iron tie rod Ø 10 mm. Finish: galvanized.

Goujon en fer, Ø 10 mm. Finition: galvanisé.

Code	A	B	C	min. order (nr)	qty/box (nr)
480/10	36	20	M6	1000	1000
480/10	36	20	M8	1000	1000
480/10	36	20	7/16	1000	1000
480/10	46	30	M6	1000	1000
480/10	46	30	M8	1000	1000

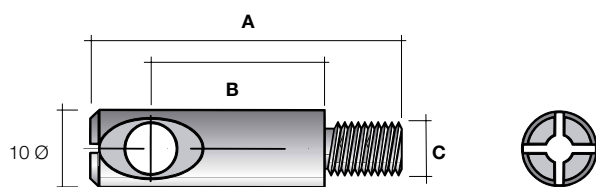

VITERIA E GIUNZIONI

SCREWS AND JOINTS

VIS ET JONCTIONS

490

Bussola ottone esagonale M6 con sfera. Finitura: ottone grezzo.

M4 hexagon brass bushing with ball. Finish: raw brass.

Douille laiton hexagonale M6 avec bille. Finition: laiton naturel.

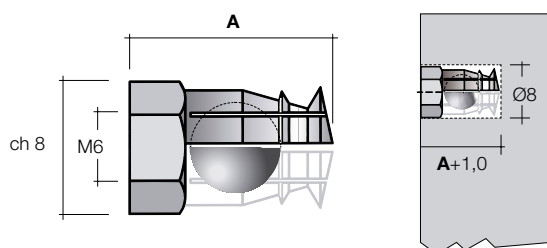

Code	A	min. order (nr)	qty/box (nr)
490	12	5000	5000
490	15	5000	5000

491

Bussola ottone esagonale M6 senza sfera. Finitura: ottone grezzo.

M4 hexagon brass bushing without ball. Finish: raw brass.

Douille laiton hexagonale M6 sans bille. Finition: laiton naturel.

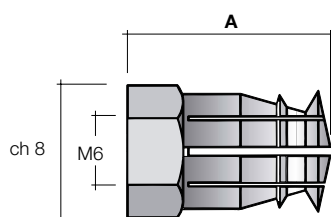

Code	A	min. order (nr)	qty/box (nr)
491	12	5000	5000
491	9	5000	5000

492

Bussola ottone esagonale M4 con sfera. Finitura: ottone grezzo.

M4 hexagon brass bushing with ball. Finish: raw brass.

Douille laiton hexagonale M4 avec bille. Finition: laiton naturel.

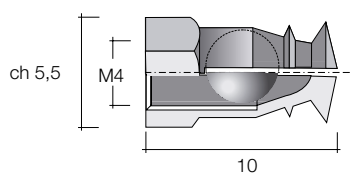

Code	min. order (nr)	qty/box (nr)
492	10000	10000

VITERIA E GIUNZIONI

SCREWS AND JOINTS

VIS ET JONCTIONS

493

Bussola ottone esagonale M4 senza sfera. Finitura: ottone grezzo.

M4 hexagon brass bushing without ball. Finish: raw brass.

Douille laiton hexagonale M4 sans bille. Finition: laiton naturel.

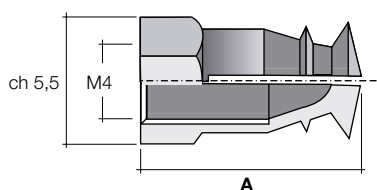

Code	A	min. order (nr)	qty./box (nr)
493	10	10000	10000
493	7,50	10000	10000

500

Bussola in zama con esagono. Finitura: zama grezzo - zincato.

Hexagon zamak bushing. Finish: untreated zamak - galvanized.

Douille en Zamak avec hexagone. Finition: Zamak naturel - galvanisé.

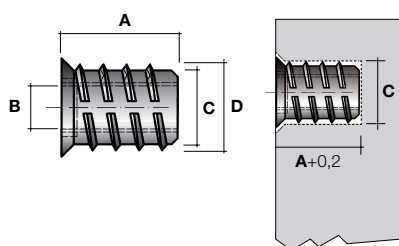

Code	A	B	C	D	min. order (nr)	qty./box (nr)
500	10	M6	Ø 8	Ø 9,5	10000	10000
500	13	M6	Ø 8	Ø 9,5	10000	10000
500	15	M6	Ø 8	Ø 9,5	5000	5000
500	17	M6	Ø 8	Ø 9,5	5000	5000
500	20	M6	Ø 8	Ø 9,5	5000	5000
500	15	M8	Ø 10	Ø 12	5000	5000
500	20	M8	Ø 10	Ø 12	2500	2500
500	22	M8	Ø 10	Ø 12	5000	5000
500	24	M8	Ø 10	Ø 12	5000	5000
500	15	7/16	Ø 10	Ø 12	5000	5000
500	18	M10	Ø 12	Ø 15	2500	2500

501

Bussola in ferro. Finitura: tropicalizzato.

Iron bushing. Finish: tropicalized.

Douille en fer. Finition: tropicalisé.

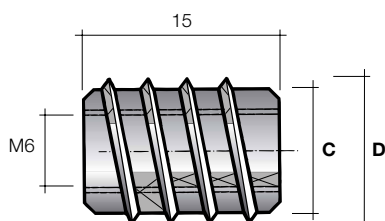

Code	C	D	min. order (nr)	qty./box (nr)
501	Ø 8	Ø 10		3000
501	Ø 10	Ø 12	2000	2000

VITERIA E GIUNZIONI

SCREWS AND JOINTS

VIS ET JONCTIONS

502

Bussola in ferro. Finitura: tropicalizzato.

Iron bushing. Finish: tropicalized.

Douille en fer. Finition: tropicalisé.

Code	A	B	C	D	min. order (nr)	qty./box (nr)
502	15	M6	∅ 8	∅ 10	10000	10000
502	15	M6	∅ 10	∅ 12	5000	5000
502	15	7/16	∅ 10	∅ 12	5000	5000
502	16	M10	∅ 12,5	∅ 15	5000	5000

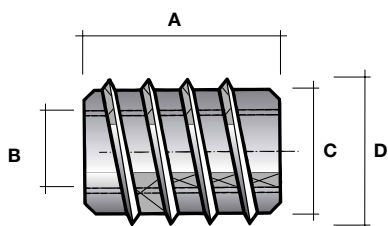
**450**

Inserto ∅ 18 mm in plastica. Finitura: bianco.

Plastic ∅ 18 mm insert. Finish: white.

Insert ∅ 18 mm en plastique. Finition: blanc.

Code	A	C	min. order (nr)	qty./box (nr)
450	13	16	5000	5000
450	14,20	18/19	5000	5000
450	17	23	5000	5000

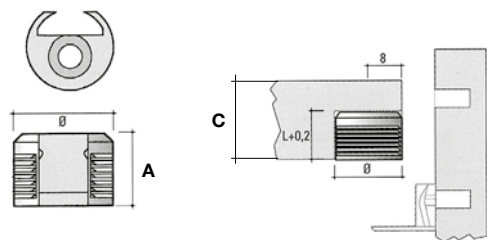
**451/18**

Inserto ∅ 18 mm in zama e plastica. Finitura: bianco e zama grezzo.

Zamak and plastic ∅ 18 mm insert. Finish: white and untreated zamak.

Insert ∅ 18 mm en Zamak et en plastique. Finition: blanc et Zamak naturel.

Code	A	C	min. order (nr)	qty./box (nr)
451/18	13	16	5000	5000
451/18	14,20	18/19	5000	5000
451/18	17	23	5000	5000
451/18	18,40	26	5000	5000
451/18	20	28/30	5000	5000

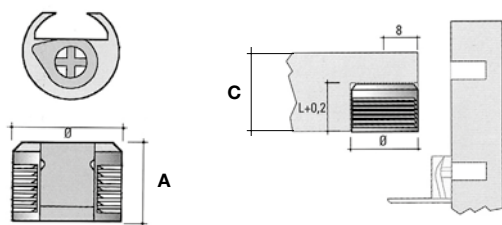

VITERIA E GIUNZIONI

SCREWS AND JOINTS

VIS ET JONCTIONS

451/20

Inserto Ø 20 mm in zama e plastica. Finitura: bianco e zama grezzo.

Zamak and plastic Ø 20 mm insert. Finish: white and untreated zamak.

Insert Ø 20 mm en Zamak et en plastique. Finition: blanc et Zamak naturel.

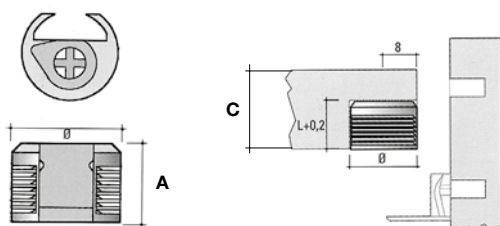

Code	A	C	min. order (nr)	qty/box (nr)
451/20	14	18/19	5000	5000
451/20	17,60	26	5000	5000
451/20	20,30	28/30	2500	2500

455

Staffa in zama per Art. 450. Finitura: nichelato - zincato nero - bronzato - ottonato.

Zamak bracket for Art. 450. Finish: nickel-plated - galvanized black - bronzed - brass-plated.

Support fixe en Zamak pour l'Art. 450. Finition: nickelé - galvanisé noir - bronzé - laitonné.

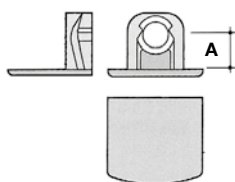

Code	A	C	min. order (nr)	qty/box (nr)
455	8	16	2000	2000
455	9	18/19	2000	2000
455	11,50	23	2000	2000

456

Staffa in zama per Art. 451. Finitura: nichelato - zincato nero - bronzato - ottonato.

Zamak bracket for Art. 451. Finish: nickel-plated - galvanized black - bronzed - brass-plated.

Support fixe en Zamak pour l'Art. 451. Finition: nickelé - galvanisé noir - bronzé - laitonné.

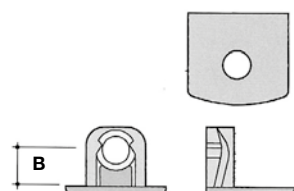

Code	B	C	min. order (nr)	qty/box (nr)
456	8	16	2000	2000
456	9	18/19	2000	2000
456	11,50	23	2000	2000
456	13	26	1250	1250
456	14,50	28/30	1250	1250